

Pinch Analysis: For the Efficient Use

OF ENERGY, WATER & HYDROGEN



Natural Resources
Canada

Ressources naturelles
Canada

Canada

Pinch Analysis: For the Efficient Use

O F E N E R G Y , W A T E R & H Y D R O G E N

ISBN: 0-662-34964-4
Catalogue # M39-96/2003E

© Her Majesty the Queen in Right of Canada, 2003

Ce guide est également disponible en version française sous le titre de :
L'analyse Pinch : pour une utilisation efficace de l'énergie, de l'eau et de l'hydrogène

An electronic copy of this guide can be found at:
<http://canmetenergy.nrcan.gc.ca>

This publication is distributed for informational purposes only and does not necessarily reflect the views of the Government of Canada. Neither Canada, nor its ministers, officers, employees and agents make any warranty in respect to this publication nor assume any liability arising out of this publication.

Table of Contents

1 INTRODUCTION	5
1.1 Objectives of this guide	5
1.2 What is process integration (PI)?	5
1.3 Pinch analysis: the most widely used PI approach	7
2 A STRUCTURED APPROACH TO UTILITY MANAGEMENT	9
2.1 The value of a structured approach	9
2.2 Combining analysis and synthesis	11
Analysis phase	11
Synthesis phase	14
2.3 Putting it all together	15
3 THE BASICS OF PINCH ANALYSIS	19
3.1 The pinch concept	19
3.2 Energy pinch	21
Building the composite curves	22
Determining the energy targets	25
Selection of ΔT_{min}	26
Data extraction	28
Targeting for multiple utilities: the grand composite curve	30
Cogeneration	32
Heat pumps	35
Process modifications: general principles	36
Process modifications: the plus-minus principle	37
The design procedure for maximum heat recovery	38
Flexibility in the design procedure	38
Site-wide analysis	39
3.3 Water pinch	46
Parallels to energy pinch	47
Multiple contaminants	49
Sensitivity analysis	49
Types of water reuse possibilities	51
A Typical water pinch study	53
3.4 Hydrogen pinch	55
Parallels with energy and water	56
Sensitivity analysis	57
A typical hydrogen pinch study	58
4 REFERENCES	61

Table of Figures

2.1	Typical Site Issues	9
2.2	Benefits of Using Pinch Technology in the Context of a Strategy Aiming at Reducing Utility Costs	11
2.3	A Structured Approach based on Pinch Analysis	12
2.4	Road Map Example	16
3.1	Schematic Process Utility Use	19
3.2	Minimize Utility Use	20
3.3	The Composite Curves	22
3.4	Construction of the Composite Curves	24
3.5	Using the Composite Curves to Determine the Energy Targets	25
3.6	Heat Transfer Across a Pinch	26
3.7	Effect of Increasing ΔT_{\min}	27
3.8	Energy / Capital Trade-off	27
3.9	Construction of the Grand Composite Curve	31
3.10	The Grand Composite Curve for Multiple Utilities Targeting	32
3.11	Integration of Heat Engine Exhaust Across and Above the Pinch	33
3.12	Gas Turbine Exhaust Taken Down to Dew Point Temperature	34
3.13	Heat Recovery from Gas Turbine Exhaust Limited by the Shape of the GCC	34
3.14	Integration of a Heat Recovery Steam Generator	35
3.15	Integration of a Heat Pump Above, Below and Across the Process Pinch	36
3.16	Schematic of a Site Operating Several Processes Linked Indirectly Through the Utilities	40
3.17	Construction of the Site-Wide Source Sink Profiles	42
3.18	Site-Wide Source Sink Profiles	43
3.19	Site-Wide Approach	44
3.20	Example of a Simplified Refinery Utility System Model	45
3.21	Water Purity Profiles	48
3.22	Mixing Streams to Reduce Freshwater Consumption and Wastewater Generation	49
3.23	Sensitivity Plots	50
3.24	Water Reuse with Changes to the Inlet Concentration	51
3.25	Water Regeneration and Reuse	52
3.26	Distributed Effluent Treatment	52
3.27	Example of a Road Map to Reduce Overall Costs for a New Wastewater Treatment System	54
3.28	Hydrogen Pinch Tools	57
3.29	Hydrogen Pinch Sensitivity Analysis for Several Units of a Refinery	58

Table of Tables

1	A Simple Example of the Data Required to Build Composite Curves	23
---	---	----

1 INTRODUCTION

1.1 Objectives of this guide

Process integration (PI) is an efficient approach that allows industries to increase their profitability through reductions in energy, water and raw materials consumption, reductions in greenhouse gas (GHG) emissions, and in waste generation. Among PI methodologies, pinch analysis is certainly the most widely used. This is due to the simplicity of its underlying concepts and, especially, to the spectacular results it has obtained in numerous projects worldwide.

The purpose of this guide is to introduce engineers to the fundamental techniques of pinch analysis. In Chapter 2, we give a general overview of how the systematic techniques used in a pinch analysis study may be used to plan and optimize a site-wide industrial process. Chapter 3 presents the basic principles of pinch analysis, as well as the various tools available to the pinch practitioner. At the same time, methods that encourage the reasonable use of energy, water, and hydrogen are developed in greater detail.

References for additional information on pinch analysis and other PI methods are listed at the end of this guide.

1.2 What is process integration?

The term “process integration” means a number of things to different people. It may be applied to a simple heat exchanger that recovers heat from a process product stream, to waste-heat recovery from a gas turbine, to the optimal scheduling of reactor usage, to the integration of a number of production units in an oil refinery, or to the complete integration of an industrial complex.

In this document, the term “Process Integration” (PI) refers to the analysis and optimization of large and complex industrial processes. PI may therefore be defined as:

All improvements made to process systems, their constituent unit operations, and their interactions to maximize the effective use of energy, water, and raw materials.

Process integration, combined with other tools such as process simulation, is a powerful approach that allows engineers to systematically analyze an industrial process and the interactions between its various parts.

PI techniques may be applied to address the following industrial issues:

- Energy saving, and GHG emission reduction
- Debottlenecking of the critical areas in a given process
- Optimization of batch processes
- Optimization of hydrogen use
- Reactor design and operation improvements
- Minimization of water use and wastewater production
- Optimization of separation sequences
- Waste minimization
- Utility system optimization¹
- Investment cost reduction

In general, PI's added value, compared to that of traditional approaches, is particularly significant for large and complex industrial facilities. This is because the more complex the process becomes, the harder it is to identify the best saving opportunities without using systematic approaches such as PI.

1. In this document, utilities refers to those used principally for heating (steam at various pressure levels, furnace flue gas, hot oil, hot water, etc.), or for cooling (cooling water, glycol, refrigerant, cooling air, etc.).

1.3 Pinch Analysis: the most widely used PI approach

One of the most practical tools to emerge in the field of process integration in the past 20 years has been pinch analysis, which may be used to improve the efficient use of energy, hydrogen and water in industrial processes. Pinch analysis is a recognized and well-proven method in each of the following industry sectors:

- Chemicals
- Petrochemicals
- Oil refining
- Pulp & paper
- Food & drink
- Steel & metallurgy

Over the past 20 years, pinch analysis has evolved and its techniques perfected. It provides tools that allow us to investigate the energy flows within a process, and to identify the most economical ways of maximizing heat recovery and of minimizing the demand for external utilities (e.g., steam and cooling water). The approach may be used to identify energy-saving projects within a process or utility systems.

The ideal time to apply pinch analysis is during the planning of process modifications that will require major investments, and before the finalization of process design. Maximum improvements in energy efficiency, along with reduced investments can be obtained in a new plant design, since many plant-layout and -process constraints can be overcome by redesign.

However, in retrofit projects, energy efficiency improvements usually require some capital expenditure. In this case, pinch analysis can be specifically aimed at maximizing the return on investment. Pinch analysis techniques allow us to evaluate combinations of project ideas simultaneously, in order to avoid “double-counting” savings, as well as conflicting projects. Indeed, the final investment strategy for the available opportunities will ensure that site development is consistent and synergistic.

An important part of pinch analysis is the establishment of minimum energy consumption targets (of water or hydrogen) for a given process or plant. This information enables us to identify the maximum potential for improvement before beginning the detailed design process. This approach may be applied systematically to a plant's individual processes, or it may be applied plant-wide.

The use of specialized software is generally required to increase the speed of processing and analyzing the large amount of data involved in a pinch analysis. Some software applications also offer tools to rapidly design or modify heat exchanger networks.

A model of the site's utility systems (for both production and distribution) is generally produced in parallel with the pinch analysis study. Through this model, all savings identified within the processes can be directly related to savings in the purchase of primary energy sources.

Over the past 20 years, hundreds of pinch analyses have been successfully used to reduce energy consumption site-wide, and in individual processes. More recently, pinch analysis has also achieved spectacular results in the optimization of water and hydrogen consumption.

The application of pinch analysis (in industrial sectors such as oil refining, chemicals, iron and steel, pulp and paper, petrochemicals, and food & drink) can typically identify:

- Savings in energy consumption: 10% to 35 %²
- Savings in water consumption: 25% to 40 %
- Savings in hydrogen consumption: up to 20 %³

2. Energy savings are expressed as a percentage of total energy consumption (except for pulp and paper, where they are expressed as a percentage of total steam production).
3. Oil refineries only.

2

A STRUCTURED APPROACH TO UTILITY MANAGEMENT

2.1 The value of a structured approach

At any one time, site managers may be under pressure to meet new environmental limits, improve efficiency and increase plant capacity (**Figure 2.1**). Any of these, on its own, is likely to require project management and engineering time for its development, and capital investment for its implementation.

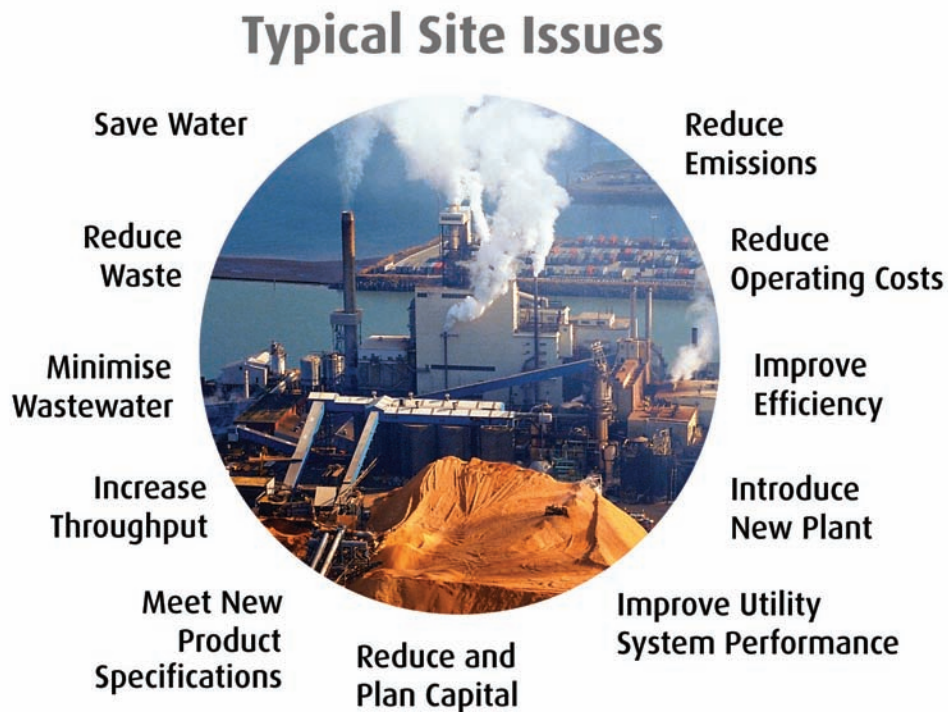

Figure 2.1

Typical
Site Issues

The problem is therefore highly complex: on the one hand, we have targets to meet, whether they be set by legislation or industry benchmarks; on the other hand, we want to minimize capital investment and ensure that we have the optimum solution.

In many situations, it is possible, without applying any specific methodology, to identify utility infrastructure improvements that meet immediate needs, as well as save operating costs. The difficulty lies in judging how good a solution really is. For example:

- There may be a number of alternative projects that would equally solve the immediate problem, but that offer larger savings, or lower capital investment. We want to ascertain that all such options are considered and evaluated.
- It is possible that the solution we identified makes future improvements more expensive, or even impossible to justify. We need to develop projects that are compatible with each other, and that may be combined to meet our overall goal.

It is essential to have a systematic approach that allows the identification not only of individual projects, but also of project combinations that meet longer term aims. By structuring solutions, we can also:

- Minimize operating costs;
- Minimize and plan capital investment;
- Minimize engineering time and effort.

An important part of pinch analysis is the establishment of minimum achievable consumption targets for the energy, water and/or hydrogen required to operate the process. From representative heat and mass balance for a process, we create a model representing the most important energy and/or material flows. This representation allows us to:

- Define targets for the minimum potential consumption and the maximum potential savings:

The difference between the minimum consumption and the current situation is the saving potential

- Identify sources of inefficiency, which allows us to determine what may practically be achieved.
- Determine the key areas in which improvement may be achieved, so that efforts may be focused where it is most required.

By setting targets for minimum consumption for the process, pinch analysis provides us with a view of the entire system, which ensures projects compatibility and completeness. Precisely because the system is analyzed as a whole, new and significant improvements are often found where none were expected (*Figure 2.2*).

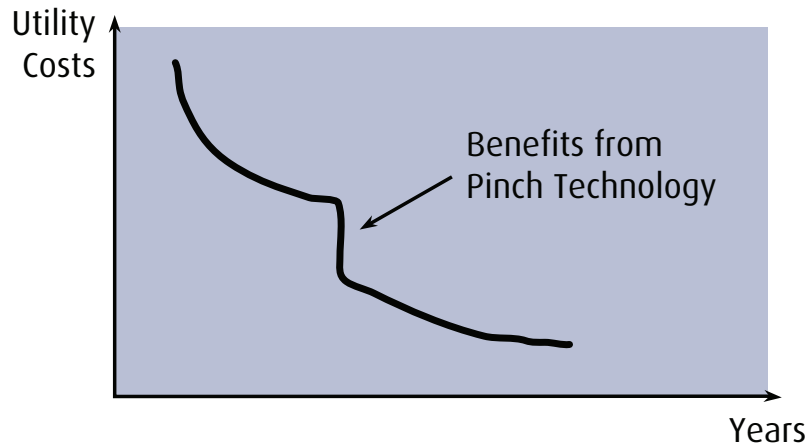
**Figure 2.2**

Benefits of Using Pinch Technology in the Context of a Strategy Aiming at Reducing Utility Costs

2.2 Combining analysis and synthesis

An effective way to approach the complexities of energy, water and hydrogen systems is to divide the problem into **Analysis** and **Synthesis Phases**. The goal of this section is not to present the fundamentals of pinch methodology in detail, but to give an overview of the phases that comprise a pinch analysis (the pinch methodology is presented more in detail in *Section 3*).

Analysis phase

Figure 2.3 shows a breakdown of tasks normally performed during a typical pinch study. The dark blue (heavily shaded) boxes are pinch-related activities; the light blue (lightly shaded) boxes are activities that generally require some site input.

Figure 2.3

A Structured Approach based on Pinch Analysis

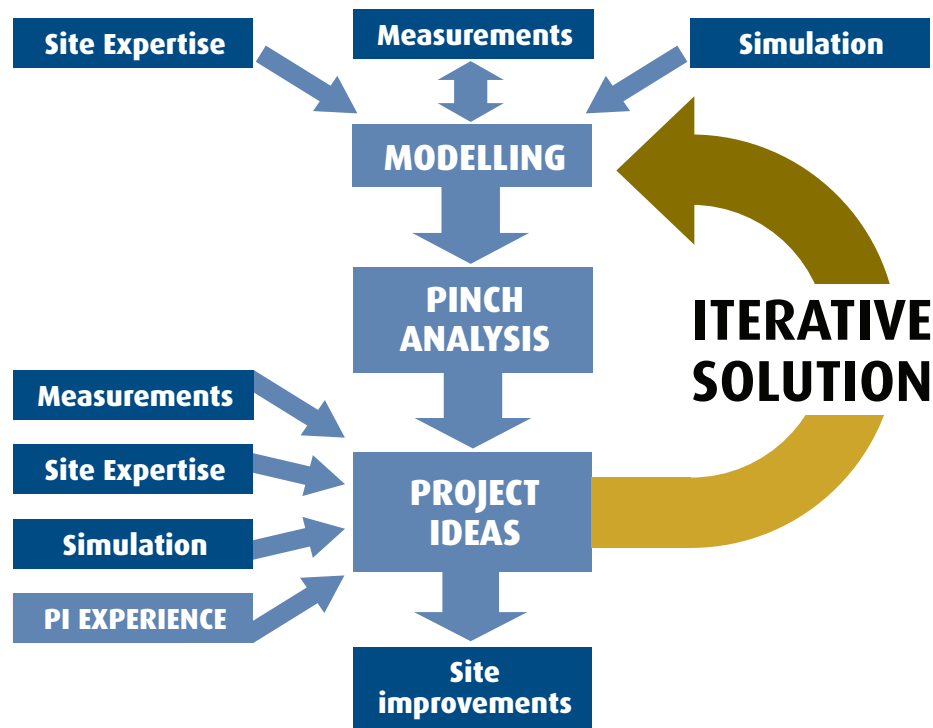

The first activities in any analysis are data collection and validation. Data can be generated from measurements of plant operation, simulation and design data.

All three types of data are valuable for performing a pinch analysis:

- **Measurements** define the process currently in operation. As such, this is the most appropriate basis for evaluating proposed improvements. However, measurements may sometimes be inconsistent with each other.
- **Simulation** includes the previous category, and delivers a consistent heat and mass balance, which makes this the best data source for a study. However, developing simulations may require significant effort. Depending on the process' complexity, the required accuracy of results, and the available human and financial resources, the pinch engineer, together with the plant's management, will decide if simulation is required. More importantly, the pinch engineer will identify target areas, and the detail level required by the analysis. Focus may then be placed where it is really required. It is important to recall that simulation may be used not only to provide analysis data, but also to predict the results and impacts of projects that will be recommended following the pinch study, as well as the impacts of future production projects.

- **Design data** may be used where **Measurements** cannot be performed. This type of data must be evaluated carefully because the plant may not be operating in its initial design conditions. These data may also be useful to evaluate if the pinch analysis recommendations may be realized with existing equipment, and what, if any, additional equipment is required.

At this stage, input from process operators is critical. First of all, they can assess the validity of data, based on their experience of operating the plant. Second, operators and plant engineers are best placed to define specific process constraints. For example, they will know a unit's maximum inlet temperature, or pressure limitations. Third, they are familiar with the process dynamics, such as fouling or coking. Also, the early involvement of the plant's personnel generally increases the implementation rate of recommended projects, which is the key to producing real benefits.

All this information is used to develop models of the process. Depending on the objectives of the study and the complexity of the process, these can range from simple mass balances to rigorous simulations representing both process and utility systems. Apart from traditional simulation models, pinch models of the processes and utility system are also developed (see *Section 3* for more details on the pinch models).

Developing simulation and pinch models aims to:

Aid understanding of the issues

Often it is only through the use of models that interactions within a process or utility system can be appreciated. For example, current process operating conditions may be shown to be energy inefficient, resulting in the development of a new scheme.

Simulate processes

It is important to know what is going to happen, within a process, when a modification is made. For example, changing the operating pressure of a distillation column to improve heat recovery may seem a very attractive idea, but it is vital to know if the column will still achieve its present performance under the new conditions.

Determine costs

Models are used to determine the true cost of utilities and to identify where lies the greatest potential for improvement. This avoids the common error of recommending energy-saving projects for one part of the site, thereby shifting the problem to another part of the site and resulting in no real improvement in the overall energy consumption. For example, low-pressure steam may be valued at five dollars per tonne, but if the system has a permanently open steam vent, this is not the true value of that steam. If we reduce the process consumption of low-pressure steam, we will simply increase the flow through the vent, and not save anything. Low-pressure steam will only have a value if we can install projects that will close the vent.

Confirm results

Finally, models allow us to confirm that proposed modifications will achieve real savings in our system, taking into account the operating constraints of existing and new equipment.

Synthesis phase

The models and balances developed in the Analysis Phase become the foundation for the Synthesis Phase, where improvements are systematically targeted (as shown in *Figure 2.3*).

Generating an optimal integration scheme and comparing it with the existing process, makes it possible to identify the inefficiencies in the system (see *Section 3*). In the Synthesis Phase, the aim is to develop project ideas that correct the identified inefficiencies. At this stage, it is once again vital to have input from process experts, and to have, where necessary, additional measurements and simulations.

This input does not only help to fully define projects, but can also provide new insights that must then be incorporated into the process models. Solutions are therefore often iterative, with the development of project ideas sparking modifications to the models, which then generate further ideas.

The end result of the Synthesis Phase is a package of compatible and practical improvements that have the agreement of the pinch and process experts, as well as the plant's personnel.

One of the key benefits of pinch analysis' structured approach to energy, water, and/or hydrogen management is *completeness*. Once the analysis is finished, we can be sure that we understand where all the inefficiencies lie. We know which inefficiencies may be corrected within our stated economic criteria, which process changes are beneficial, and we have compared the best alternatives on a common basis.

2.3 Putting it all together

Figure 2.1 showed a range of typical issues related to industrial site operation. Some of these issues, such as reducing production costs, improving efficiency, reducing emissions, and minimizing wastewater are frequently addressed with pinch analysis. Others, such as the following, are less frequently addressed:

Introduce new plant

As mentioned above, pinch analysis allows us to identify the minimum energy, water and/or hydrogen requirements of a new process or plant. More importantly, the techniques determine the most appropriate integration within the existing units, in order to determine the minimum possible modifications in the existing energy, water, and/or hydrogen production and distribution system and, hence, if investments, are required.

Increase throughput / meet new product specifications

Similarly to introducing a new plant, increasing throughput or meeting new product specifications can place additional demands on the utility system. This can be significant in terms of increased operating cost, but may become critical if capacity limits are approached.

For example, economic expansion may be threatened if additional capacity for wastewater treatment is required. Water pinch application has been shown to reduce, and even completely avoid, the necessity for investment in additional capacity.

Another common problem is limited boiler and/or cooling capacities. The latter may be provided by river water or cooling towers. Applying pinch analysis to the energy system will identify opportunities to reduce hot and cold utility consumption, which will either avoid or, at least, reduce potentially large investments for these utility systems.

Improve utility system performance

The utility system is central to plant operations, but is often regarded as peripheral, since energy is less expensive than products. Consequently, the utility system is often operated sub-optimally as long as the desired production is being achieved.

Pinch techniques can identify inefficiencies in site-wide utility use, and propose plans for exploiting existing potential. In many cases, it is possible to balance the steam supply to consumers, while improving the way existing steam turbines are used to generate power.

Reduce and plan capital

The essence of most of the above points is the avoidance/reduction of capital investment. However, it is easy to argue that, while a particular project may answer today’s problem, it may not answer tomorrow’s. It is difficult enough to determine the most attractive investment for now, considering the range of external influences to take into account, such as new environmental legislation, proposed new taxes, changing utility tariffs, company plans for expansion, the installation of new plants and the closing of old plants, etc. The problem is even more complex when investment planning takes into consideration a company’s longer-term goals. The solution can however be represented as an investment strategy road map (Figure 2.4).

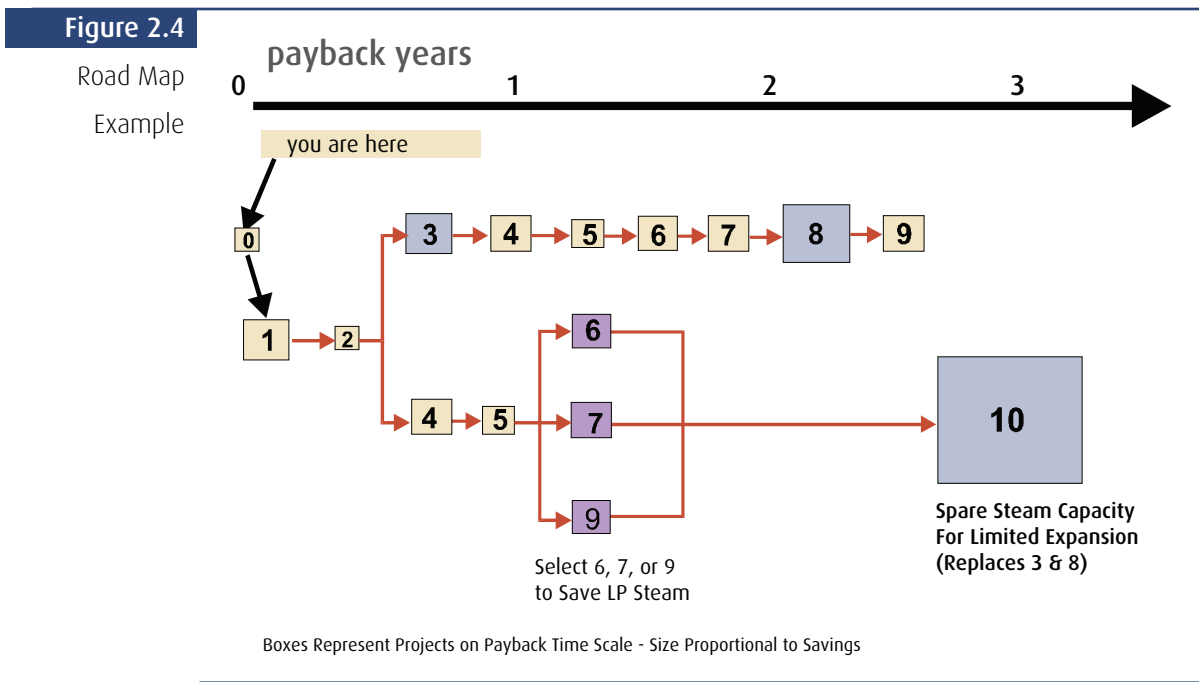

The road map details process improvement projects and utility system projects in terms of:

- Operating cost savings
- Emissions reduction
- Investment costs
- Compatibility with other projects

Alternative routes in the road map represent different investment strategies, with details about the cost and benefits of the available options. For instance, the example in *Figure 2.4* shows that projects 1 and 2 are short payback projects that can be implemented regardless of the strategy chosen. However, from that point on, there are two significantly different paths.

The first option is to implement process projects 3-9. All of these projects are compatible with each other and have a combined payback of less than two years. If investment budgets are limited, and a payback limit of two years is specified, this would be the optimal investment route.

However, the alternative route shows what could be achieved by pushing these limits back. In this case, the strategy is to implement only some of the projects between 3 and 9. Project 10 is an alternative to projects 3 and 8, but falls outside the generally accepted investment criteria of a two-year payback. However, it opens up the potential for much greater savings. This could be achieved, for example, by sufficiently reducing steam consumption, so that one of the steam boilers could be shut down.

3 THE BASICS OF PINCH ANALYSIS

3.1 The pinch concept

Pinch analysis (or pinch technology) is a rigorous, structured approach that may be used to tackle a wide range of improvements related to process and site utility. This includes opportunities such as reducing operating costs, debottlenecking processes, improving efficiency, and reducing and planning capital investment.

Major reasons for the success of pinch analysis are the simplicity of the concepts behind the approach, and the impressive results it has been obtained worldwide. It analyzes a commodity, principally energy (energy pinch), hydrogen (hydrogen pinch), or water (water pinch), in terms of its quality and quantity, recognizing the fact that the cost of using that commodity will be a function of both.

In general, we are using high-value utilities in our process and rejecting waste at a lower value (*Figure 3.1*). For example, if we consider energy, we may be burning expensive natural gas to provide the process with high temperatures heat, and are rejecting heat at low temperatures to cooling water or air. In the case of water, we feed pure water to our process and reject contaminated wastewater to treatment plants. For process gases, such as hydrogen, the expensive utility is the pure gas that is either produced on-site or imported.

Pinch analysis now has an established track record in energy saving, water reduction, and hydrogen system optimization. In all cases, the fundamental principle behind the approach is the ability to match individual demand for a commodity with a suitable supply. The suitability of the match depends on

the quality required and the quality offered. In the context of utility management, the commodity may be heat, with its quality measured as temperature; or it may be water or hydrogen, the quality of which would be purity or pressure, for example. By maximizing the match between supplies and demands, we minimize the import of purchased utilities (*Figure 3.2*).

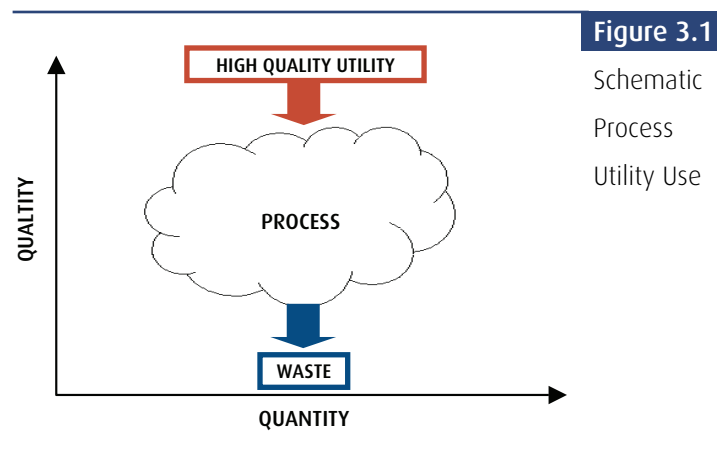
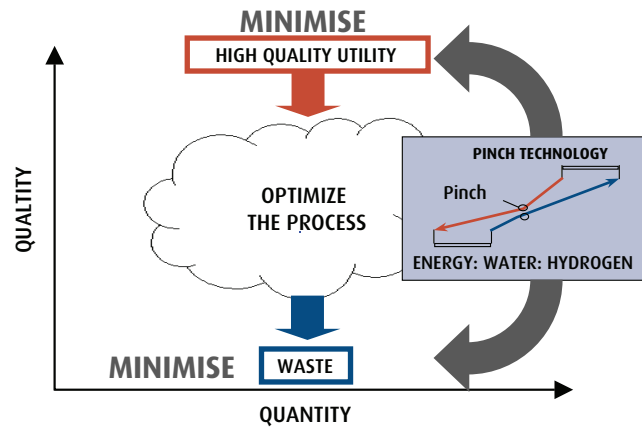

Figure 3.1

Schematic
Process
Utility Use

Figure 3.2

Minimize
Utility Use



For example, energy pinch identifies the minimum cost of hot utility targets, as well as the projects that allow us to reach these targets in practice (or to get close to them).

When considering any pinch-type problem, whether it be related to energy, water, or process gas, the same principles apply:

- Processes can be defined in terms of supplies and demands (*sources and sinks*) of commodities (energy, water, etc.).
- The *optimal solution* is achieved by appropriately matching suitable sources and sinks.
- The defining parameter in determining the suitability of matches is *quality*, e.g. temperature or purity.
- *Inefficient transfer* of resources means that the *optimal solution* cannot be achieved. In fact, the amount of inefficient transfer is equal to the wasteful use of imported commodities. (This principle is presented in more detail in *Figure 3.6.*)

The next section describes the fundamentals of energy pinch analysis, while the two sections that follow briefly present water pinch and hydrogen pinch methodologies.

3.2 Energy pinch

Energy is fundamental in industrial economies and yet is often overlooked in the drive for profitability. Recent energy-market developments, including deregulation, increasing oil and gas prices, as well as the effect of combustion gas on climate change (CO₂ is a greenhouse gas), have created a new emphasis on energy management.

Pinch analysis is a rigorous, structured approach for identifying inefficiencies in industrial process energy use. It is a well-proven technique, and has an established track record of generating economically attractive heat-recovery projects that minimize both energy consumption and capital investment when applied to individual processes or site-wide.

The approach's primary focus is the energy used in individual processes. The minimum theoretical utility requirement in the process (target) is calculated for overall energy use, as well as for specific utilities (LP, MP, HP steam, cooling water, etc.) ahead of any design activities. This allows optimization not only of the total energy demand, but also of the efficiency with which it is delivered to the process. Where appropriate, pinch-based techniques may be used to extend the analysis to the site-wide integration of a number of processes, by means of the utility system. Basics on a site-wide approach will be presented later in this document.

Since pinch analysis is a highly structured method, it results in an evaluation of all practical and viable improvement options, individually and in combination with each other. The proposals are then compiled in an investment strategy road map (see **Figure 2.4**), which details savings, capital cost, and emissions reduction. More significantly, the approach readily identifies the compatibility of projects with each other and with the available utility system. These issues are also incorporated into the road map.

Typical savings identified through the application of energy pinch, and expressed as a percentage of the TOTAL purchased fuel (except for P&P, where they are expressed as a percentage of total steam production), are as follows:

- Oil refining 10-25%
- Petrochemicals 15-25%
- Iron & steel 10-30%
- Chemicals 15-35%
- Food & drink 20-35%
- Pulp & paper 15-30%

Not all these potential savings are achieved in practice. Some projects are not implemented by plant personnel because projects fail to meet investment criteria, or because they are perceived to have potential operating problems, such as controllability or product quality. Additional energy savings, in the range of 5% to 15%, can generally be obtained from opportunities identified using more conventional methods/projects, such as good housekeeping (steam traps and leaks, boiler and furnace tuning, cleaning of fouled heat exchangers, etc.), monitoring and targeting (M&T), process modifications, etc. The exact numbers vary, depending on the amount of attention paid to energy at the facility before these methods are applied, and depending on other factors, such as the complexity of the plant, and the fouling potential of the materials being handled.

Building the composite curves

One of the principal tools of pinch analysis is the graphic representation of composite curves, the construction of which is simple but powerful. Composite curves are used to determine the minimum energy-consumption target for a given process. The curves are profiles of a process' heat availability (hot composite curve) and heat demands (cold composite curve). The degree to which the curves overlap is a measure of the potential for heat recovery, as illustrated in *Figure 3.3*.

Figure 3.3

The Composite Curves

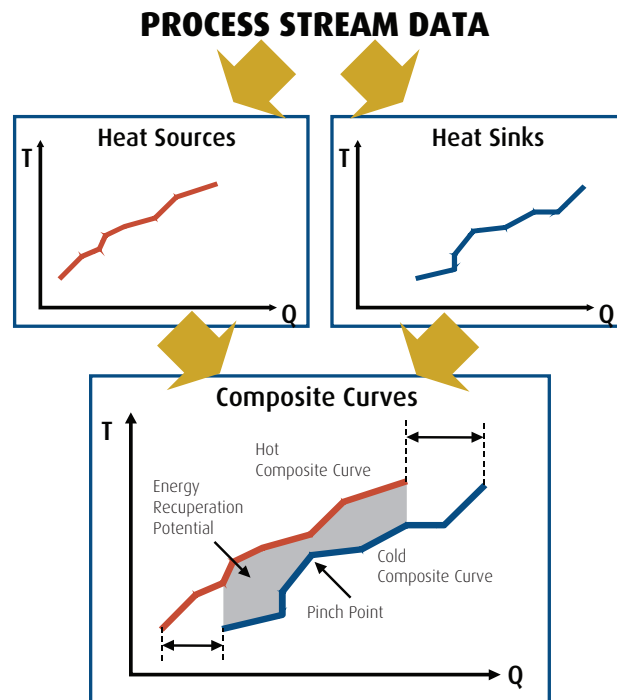

Constructing the curves requires only a complete and consistent heat and mass balance of the process in question. Data from the heat and mass balance are first used to define process streams in terms of their temperature and heating or cooling requirements. As discussed in *Section 2.2*, this data may be produced from one or all of the following:

- Plant measurements
- Design data
- Simulation

Once identified, these process streams are then divided into sources and sinks.

A “source” corresponds to a stream that has available heat to be recovered, or that must be cooled to satisfy process needs. A “sink” represents a stream that must be heated. Because energy can be recovered from “sources”, this type of stream is called a “hot” stream. Similarly, because “sinks” require heat, this type of stream is called a “cold” stream. The procedure that first identifies the process streams required for pinch analysis, then divides these streams into sources and sinks is referred to as *data extraction*. It is a crucial part of any pinch analysis. The basics of this procedure are presented further in this section.

Stream	Stream type	Supply Temperature (°C)	Target Temperature (°C)	Duty (kW)	CP (kW/°C)
1	Hot	200	100	2000	20
2	Hot	150	60	3600	40
3	Cold	80	120	3200	80
4	Cold	50	220	2550	15

Table 1: A Simple Example of the Data Required to Build Composite Curves

This example has two hot streams (Streams 1 and 2) and two cold streams (Streams 3 and 4). Note that CP is defined as (mass flow rate) * (heat capacity) and is represented by the slope of the curve in *Figure 3.4*. For example, Stream 1 is cooled from 200°C to 100°C, releasing 2000 kW of heat, and so has a CP of 20 kW/°C.

Figure 3.4

Construction of the Composite Curves

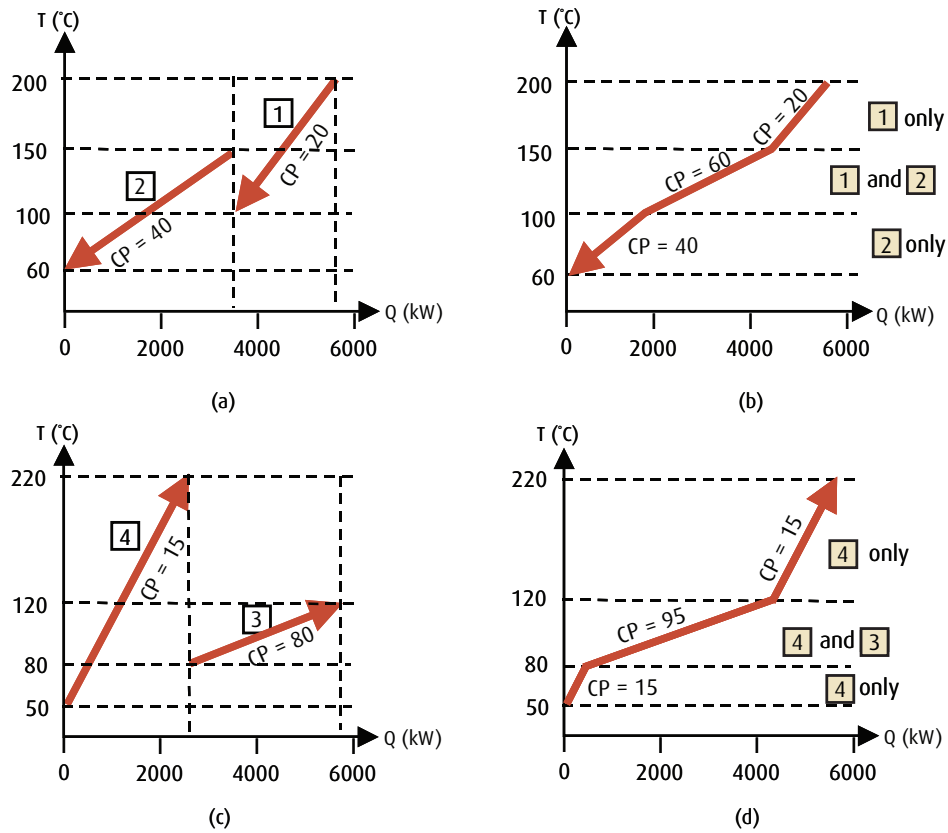
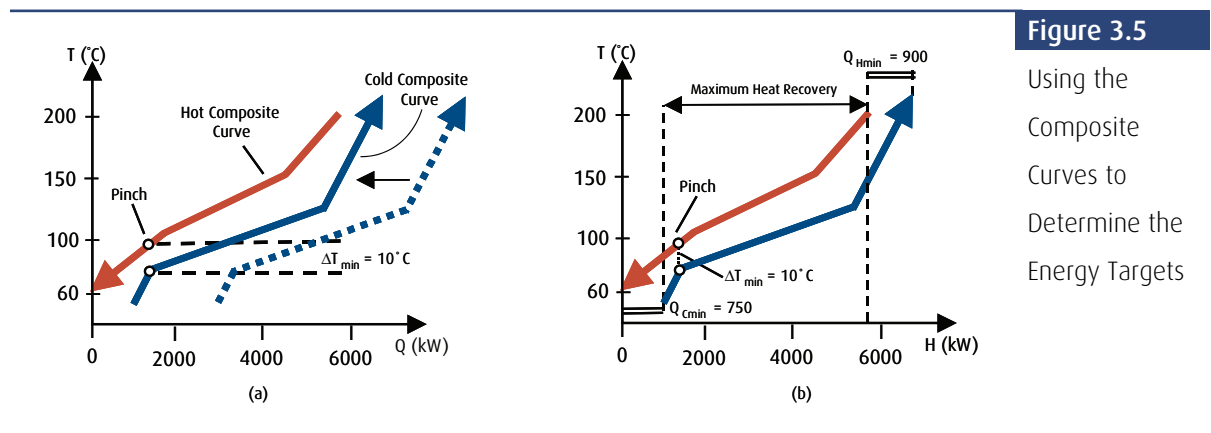

Figure 3.4(a) shows the hot streams plotted separately on a temperature-duty diagram. The hot composite curve in Figure 3.4(b) is constructed by simply adding the enthalpy changes of the individual streams within each temperature interval. In the temperature interval 200°C to 150°C, only Stream 1 is present. Therefore, the CP of the composite curve equals the CP of Stream 1, i.e., 20. In the temperature interval 150°C to 100°C, both Streams 1 and 2 are present. Here, the CP of the hot composite is the sum of the CPs of the two streams, i.e., 20+40=60. In the temperature interval 100°C to 60°C, only Stream 2 is present, so the CP of the composite is 40.

Construction of the cold composite curve is done similarly to that of the hot composite curve, but combines the temperature enthalpy curves of the cold streams (see Figures 3.4(c) and (d)).

Determining the energy targets

To determine the minimum energy target for the process, the cold composite curve is progressively moved toward the hot composite curve, as shown in **Figure 3.5(a)**. Note that the enthalpy axis measures relative quantities, which means that we are representing the *enthalpy change* of process streams. Moving a composite curve horizontally does not, in any way, change the stream data. The closest approach of the curves is defined by the minimum allowable temperature difference, ΔT_{\min} (**Figure 3.5(a)**). This value determines the minimum temperature difference that will be accepted in a heat exchanger. A value of 10°C has been used in this example. The aspects to consider in selecting the appropriate value for ΔT_{\min} are discussed in the next section.



The overlap between the composite curves shows the maximum possible process-heat recovery (as shown in **Figure 3.5(b)**), indicating that the remaining heating and cooling needs are the minimum hot utility requirement ($Q_{H\min}$) and the minimum cold utility requirement ($Q_{C\min}$) of the process for the chosen ΔT_{\min} . In this example, the minimum hot utility ($Q_{H\min}$) is 900 kW and the minimum cold utility ($Q_{C\min}$) is 750 kW.

Using pinch analysis, we are able to set targets for minimum energy consumption prior to any heat exchanger network design. This allows us to quickly identify the scope for energy savings, at an early stage of the analysis. This single benefit is likely to be the biggest strength of the approach.

The point of closest approach of the composite curves, i.e., where ΔT_{\min} is reached, is known as the pinch point. The pinch is determined by the minimum temperature difference that will be accepted in any heat exchanger. Furthermore, it divides the problem into two independent zones.

Figure 3.6

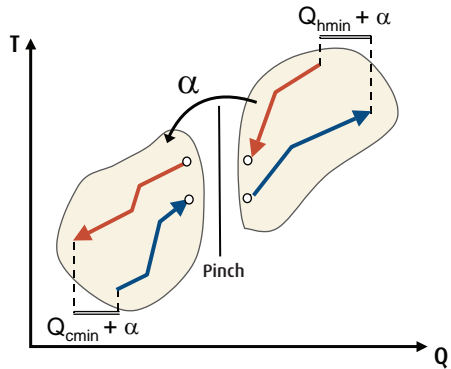
Heat Transfer
Across a Pinch

In principle, the region above the pinch (the right hand side of *Figure 3.6*) only requires hot utility to close the energy balance, while the below-pinch region (to the left of the pinch point) only requires cooling. An ideal design would reflect this arrangement. Pinch design rules instruct us not to transfer heat from a hot stream above the pinch point to a cold stream below the pinch point. If we were to transfer heat from the hot side of the pinch to the cold side, we would not meet our target. Instead,

we would need to replace this cross-pinch heat with an equivalent amount of hot utility above the pinch (α), and we would increase our consumption of cold utility below the pinch (air, cooling water, etc.) by the same amount (*Figure 3.6*).

We will have created an unnecessary cascade of energy (amount α) through the entire system, from hot to cold utility.

To meet the target, we must therefore find suitable matches for this heat on the hot side of the pinch rather than on the cold side. By analyzing the composite curves, the pinch practitioner can rapidly identify inappropriate matches that lead to an increase in hot and cold utility consumption. The design principles that allow us to achieve these targets in practice are discussed in more detail later in this section.

Selection of ΔT_{\min}

The process engineer generally assumes that there is a trade-off between energy and capital costs. Although there are occasions when pinch analysis can direct the engineer to savings in both energy and capital, saving energy generally implies increased capital spending, particularly in the case of retrofit.

This can be demonstrated by examining the composite curves. As the separation between hot and cold composite curves (ΔT_{\min}) increases, the overlap between hot and cold curves is reduced, thereby decreasing the opportunities for heat recovery from hot streams to cold streams, and, consequently, increasing the utility demand (*Figure 3.7*).

At the same time, there is an increase in the temperature-driving forces between hot and cold streams (the vertical distance between the curves), leading to greater temperature differences in the required heat exchangers, and, hence, to smaller units. In this case, the higher energy cost has been offset by the reduced capital cost of the heat exchangers. *Figure 3.8* shows a generalized relationship between capital cost and energy cost as a function of ΔT_{\min} . There is, therefore, an optimum value for ΔT_{\min} that will minimize the total cost (capital + energy) for a given plant.

If the cost of energy (\$/year) and the cost of heat exchangers (\$/m² of surface area) are known for a given plant, it is possible to predict the optimum value of ΔT_{\min} ahead of the design (for both retrofit and new design), thereby saving a significant number of engineering hours that would have been spent exploring suboptimal designs.

The procedure used to select the optimal value of ΔT_{\min} , i.e., analyzing the energy/capital trade-off, is shown step by step in the Guides produced by NRCan in which the specifics of pinch analysis are described for various industrial sectors.

In practice, the pinch specialist often selects the ΔT_{\min} value for a given process by looking at the two following factors:

- **The shape of the composite curves.** Typically, a higher value will be chosen for composite curves that are almost parallel, than for systems that diverge sharply. This is because the temperature difference between cold and hot streams, in any heat exchanger of the process, is close to the ΔT_{\min} value when the composite curves are almost parallel. In this case, a small ΔT_{\min} would result in a high heat exchange area for all heat exchangers (not only for the ones that transfer heat between streams close to the pinch point) and thus, high investment costs.

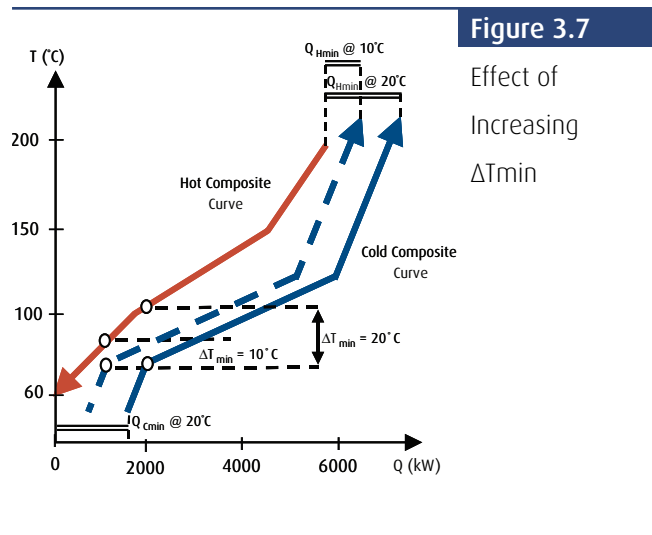

Figure 3.7

Effect of Increasing ΔT_{\min}

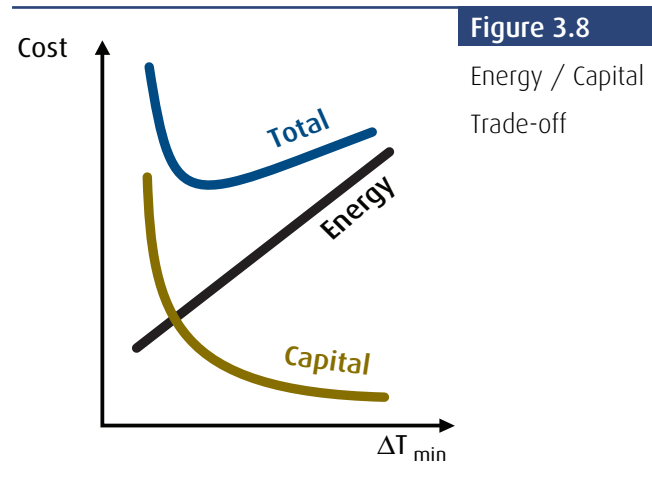

Figure 3.8

Energy / Capital Trade-off

- **Experience.** In systems where fouling readily occurs, or where heat transfer coefficients are low, typical ΔT_{\min} values of 30–40°C are used. For chemical processes, and where utilities are used for heat transfer, ΔT_{\min} values are typically in the range of 10 to 20°C. For low temperature processes using refrigeration, lower ΔT_{\min} values (3–5°C) are used to minimize expensive power demands in the refrigeration systems.

Data extraction

The amount of information available from plant measurements, data acquisition systems, DCS, and simulation models of a process can be very large, and most of this data may well be of no relevance to the analysis. It is thus necessary to identify and extract only the information that truly captures the relevant sources and sinks, and their interactions with the overall process. For an energy pinch study, we are interested in, first, identifying all parts of the process that need heating or cooling, and, then, *extracting* the data required for analysis, primarily specific thermal and flowrate data. The following general discussion may also be applied to water, mass, and hydrogen applications, with corresponding substitutions of the appropriate process variables.

Data extraction can be the most time-consuming task of a pinch study, with its data collection and process simulation tasks (see *Section 2.2*). It is essential that all the heating, cooling, and phase changes in the process be identified. In existing processes, accurate information may not be readily available, and the engineer may have to go into the field to obtain it. Modeling tools, such as simulation and data reconciliation, can be very helpful in collecting a set of consistent and reliable data.

As mentioned earlier, the key information that needs to be extracted includes the temperature levels of the process streams, and the amount of heat required to bring about desired temperature changes. Heat capacity and flowrate are key pieces of information for defining the enthalpy change for a given process stream.

In summary the data required for each process stream include:

- Mass flowrate (kg/s),
- Specific heat capacity (kJ/kg °C),
- Supply and target temperatures (°C), and
- Heat of vaporization for streams with a phase change (kJ/kg).

Additionally, the following information must be collected on utilities and existing heat exchangers:

- Existing heat exchanger area (m^2),
- Heat transfer coefficient for cold and hot sides of heat exchangers ($\text{kW}/\text{m}^2\text{°C}$),
- Utilities available in the process (water temperature, steam pressure levels, etc.),
- Marginal utility costs, as opposed to average utility costs.

Data extraction must be performed carefully as the results strongly depend on this step. A key objective of data extraction is to recognize which parts of the flowsheet are subject to change during the analysis (e.g. possibility of making modifications to the piping, or adding new heat exchangers, possibility of making temperature changes in the process or modifying the utility that heats a given piece of equipment (MP steam instead of HP steam for example), etc.). If, during extraction, all features of the flowsheet are considered to be fixed, there will clearly be no scope for improvement.

At the beginning of a project it is recommended that all process streams be included in the data extraction. Constraints regarding issues such as distance between operations, operability, control and safety concerns can be incorporated later on. By proceeding in such a fashion, it is possible to have an objective evaluation of the costs of imposing such constraints. PI specialists generally include some constraints from the beginning of the data extraction procedure. This can speed up the overall analysis, but a lot of experience is required to ensure that potentially interesting heat-recovery projects are not excluded.

There are a lot of sector specifics for data extraction. Not all can be discussed in this document. However, heuristic rules have been developed as guidelines. The following are the most relevant:

- Do not mix streams at different temperatures. Direct non-isothermal mixing acts as a heat exchanger. Such mixing may involve cross-pinch heat transfer, and should not become a fixed feature of the design. For example, if the pinch is located at 70°C , mixing a stream at 90°C with a stream at 50°C creates a cross-pinch, and will increase the energy targets. The way to extract these streams is to consider them independently, i.e., one stream with a supply temperature of 50°C and the required target temperature, and the other stream with a supply temperature of 90°C and the required target temperature.

- Do not include utility streams (steam, flue gas, cooling water, refrigerant, cooling air, etc.) in the process data unless they are involved directly in the process or they cannot be replaced. One of the goals of using pinch analysis is to reduce the usage of utilities. Therefore, if utility streams are extracted in a similar way to process streams, they will be considered as fixed requirements and no opportunities of reduction in utility use will be identified. In some cases, utility streams can be included because it is not practical to replace them by any form of heat recovery. For example, this is often the case for steam dryers, ejectors and turbine drives.
- Do not consider the existing plant layout. When selecting the inlet and outlet parameters for a process stream, existing heat exchange equipment and plant topology should not be taken into account at first. True utility targets (for cooling and heating) should be set regardless of the existing plant layout. Current plant energy consumption can then be compared with minimum energy targets. In retrofit of existing facilities, once these targets have been determined, plant layout (existing heat exchangers and piping, distances, etc.) needs to be taken into account in order to identify practical and cost-effective projects to reach or approach these targets.
- Identify hard and soft constraints on temperature levels. For example, a hard constraint would be the inlet temperature of a reactor that cannot be changed in any way, while a soft constraint would be the discharged temperature of a product going to storage, for which the target temperature is often flexible. It is sometimes possible to change the potential for heat recovery by changing some process temperatures at the data extraction phase (see the *Process Modification Section*).

Data extraction is a complex issue, and a significant part of the pinch specialist's expertise is related to building a good pinch model during the data extraction phase.

Targeting for multiple utilities: the grand composite curve

Most processes are heated and cooled using several utility levels (e.g. different steam pressure levels, hot oil circuit, furnace flue gas, cold water, refrigeration levels, etc.). To minimize energy costs, the design should maximize the use of cheaper utility levels and minimize the use of expensive utility levels. For example, it is preferable to use LP steam instead of HP steam, and cooling water instead of refrigeration.

While composite curves provide overall energy targets, they do not clearly indicate how much energy must be supplied by various utility levels. The tool used for setting multiple utilities targets is the grand composite curve, which plots process energy deficit (above the pinch) and energy surplus (below the pinch) as a function of temperature.

A small mathematical adjustment must be made to the composite curves prior to converting them to the grand composite curve. The separate hot and cold composite curves are “shifted” by moving them down (hot curve) and up (cold curve), each by $1/2 \Delta T_{\min}$ until they touch at the pinch point. The resulting composite curves are referred to as shifted curves, and have no real physical meaning. They are merely a step in the construction of the grand composite curve. This step ensures that the resulting grand composite curve shows the required zero heat flow at the pinch point.

The grand composite curve is constructed by plotting the heat load difference between hot and cold composite curves, as a function of temperature (Figure 3.9). It provides a graphical representation of the heat flow through the process—from the hot utility to those parts of the process above the pinch point, and from the process below the pinch point to the cold utility.

Because the grand composite curve represents heat flows in an ideal process, there is no heat flow through the pinch point (see earlier pinch design rules), which accounts for the general shape of the curve. The pinch point is where the curve touches the y-axis (Figure 3.9 again).

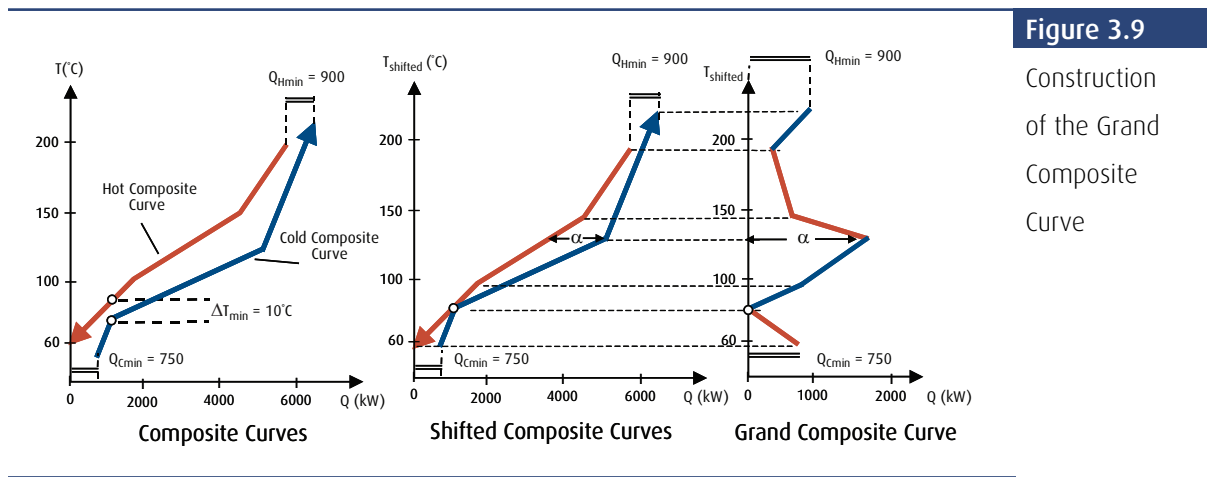
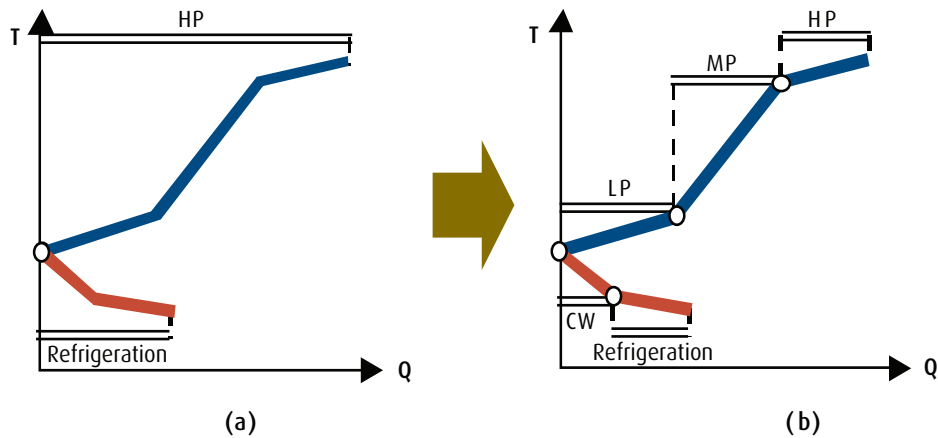

Figure 3.9
Construction of the Grand Composite Curve

Figure 3.10(a) shows a grand composite curve where high-pressure (HP) steam is used for heating, and refrigeration is used for cooling the process. In order to reduce the utility costs, we introduce intermediate utilities, medium-pressure (MP) steam, low-pressure steam (LP) and cooling water (CW). Figure 3.10(b) shows targets for all utilities.

Figure 3.10

The Grand Composite Curve for Multiple Utilities Targeting



The target for LP steam (the less costly hot utility) is first set by plotting a horizontal line at the LP steam temperature (shifted) from the y-axis until it touches the grand composite curve. The MP steam target then follows in a similar way. The remaining heating duty is finally satisfied by HP steam. This reduces HP consumption in favour of MP and LP steam, thus minimizing total utility cost. A similar construction below the pinch maximizes the use of cooling water over refrigeration.

The points where the MP, LP and CW levels touch the grand composite curve are called “utility pinches.” In a way similar to the process pinch defined previously, heat transfer across a utility pinch represents inefficiency. For the **process pinch**, the inefficiency is an increase in overall energy use above the target value. For a **utility pinch**, the inefficiency is a shift in heat load from a cheaper utility level to a more expensive one. Exactly as for the process pinch, the target for efficient utility use can be achieved by correcting the cross-utility-pinch heat transfer.

In summary, the grand composite curve is one of the basic tools used in pinch analysis for the selection of appropriate utility levels and for targeting optimal heat loads for a given set of utility levels. During targeting, appropriate loads are identified to minimize total utility costs for the various utility levels.

Cogeneration

Due to the deregulation of electricity markets in some Canadian provinces, the use of combined heat and power systems in the process industries have increased significantly. In such schemes, the heat rejected by a heat engine, such as a steam turbine, gas turbine or diesel engine, is used as a hot utility. Cogeneration units operate at much higher efficiency rates than stand-alone power generation.

Pinch analysis provides tools to identify the levels of steam that the utility system should provide to the process for optimal integration. The tools also help to calculate the heat loads on the selected steam levels (and for any other available utility, such as cooling water). As shown in the previous section, the grand composite curve (GCC) provides a convenient framework to identify the optimal loads on the various steam levels.

The efficiency of the overall utility system can be improved further by integrating the cogeneration plant with the process. Within the pinch analysis framework, there are two general ways in which one can integrate a heat engine exhaust into the process. We can choose to operate the engine across the process pinch; however, this is not efficient as the process still requires the same amount of utilities (Q_{Hmin}) and the heat engine performance remains as though stand-alone. **Figure 3.11(a)** shows a heat engine operating across a process pinch where the key heat flows are highlighted.

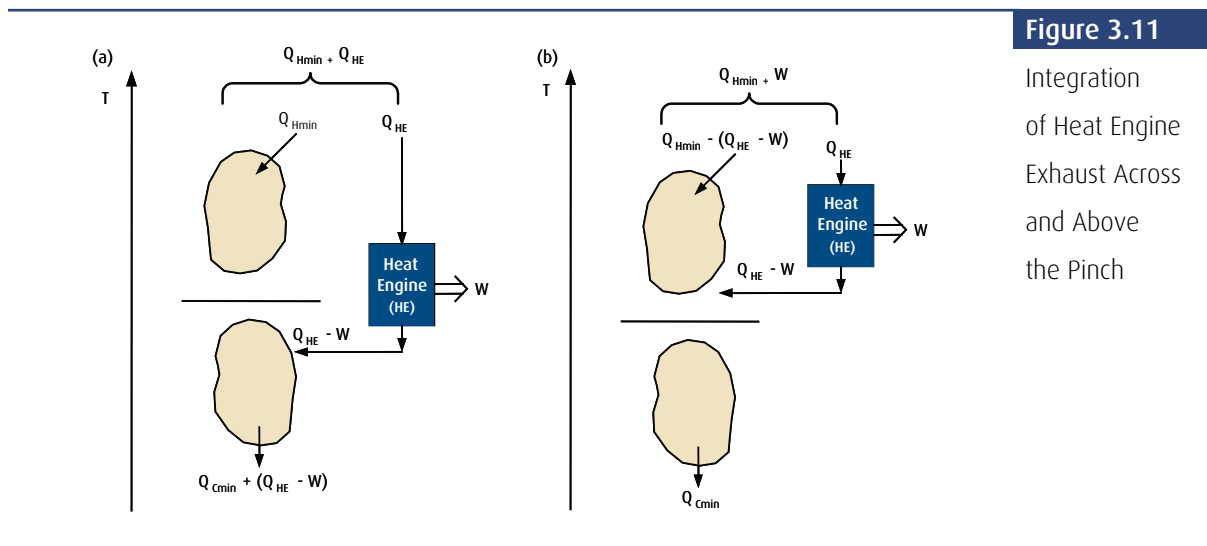

If we integrate the heat engine completely above the pinch, we reject heat to the heat-sink region of the process, thus exploiting temperature differences between the utility and the process, and producing work at a very high efficiency. The net effect is the import of a W amount of extra energy from heat sources to produce W shaftwork. Because of the integration, the efficiency of the heat to work conversion appears to be 100%. A similar situation arises when it is feasible to integrate the engine completely below the process pinch. **Figure 3.11(b)** shows an engine located completely above the process pinch.

In summary, if a heat engine is placed across the process pinch, there is no benefit whatsoever from integration. Compare this with the potential of achieving 100% efficiency in the generation of useful work.

Figure 3.12

Gas Turbine
Exhaust Taken
Down to
Dew Point
Temperature

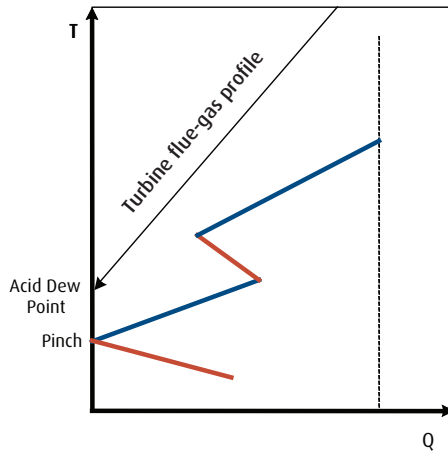
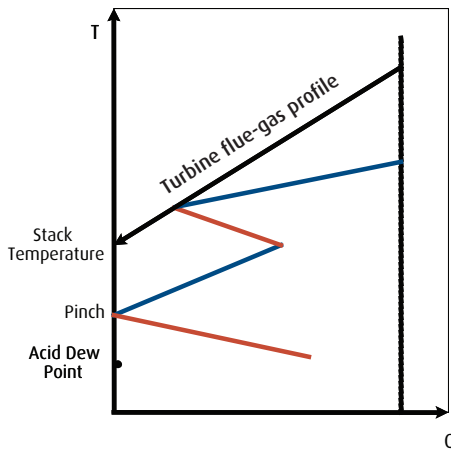

Figure 3.13

Heat Recovery
from Gas
Turbine Exhaust
Limited
by the Shape
of the GCC



The most commonly used heat engines are steam and gas turbines (using natural gas or process gas). Depending on the details of the steam distribution system and on whether the integration is performed directly with the process, heat losses will reduce the efficiency from the theoretical 100%. In the case of gas turbines, the overall efficiency ultimately depends on the turbine exhaust profile, the process pinch temperature, and the shape of the grand composite curve. For example, **Figure 3.12** shows a GCC where heat recovery is limited by the dew point temperature in the stack. **Figure 3.13** shows another GCC where heat recovery is limited by the shape of the GCC, and not by the dew point temperature.

The GCC can clearly indicate the key sizing parameters for gas and steam turbines. Steam demands in the process, at various pressure levels, are identified (see **Figure 3.10**), and the overall fuel demands and work production may be calculated. Similarly the amount of heat that may be recovered from a gas turbine exhaust is readily identified using the GCC.

Heat recovery from the exhaust of a gas turbine may be performed via a stand-alone heat-recovery steam generator (HRSG), via a HRSG combined with a steam turbine, or via direct integration with the process. The use of a HRSG provides considerable flexibility to the operation; however, it imposes thermodynamic inefficiencies and has capital cost implications. **Figure 3.14** shows the HRSG system, and flue gas temperature profiles. There is a trade-off that must be considered in selecting a turbine: the maximum work efficiency of a stand-alone unit may not be the optimal setting for cogeneration, because heat recovery increases the overall efficiency.

Once the gas turbine has been selected, the final design may have to be modified. In many cases, a heat surplus may be accommodated by the process itself; however, if this is not possible, a recuperator should be considered. A recuperator is an exchanger whose purpose is to preheat air, and which is located between the turbine compressor and its combustion chamber. The effect of this addition is to either increase the flame temperature or to reduce fuel consumption. Water may also be injected across the front of the recuperator to increase mass flow through the turbine. This has the effect of reducing flame temperature for a given power output, which, in turn, can reduce NO_x emissions often related to high flame temperature.

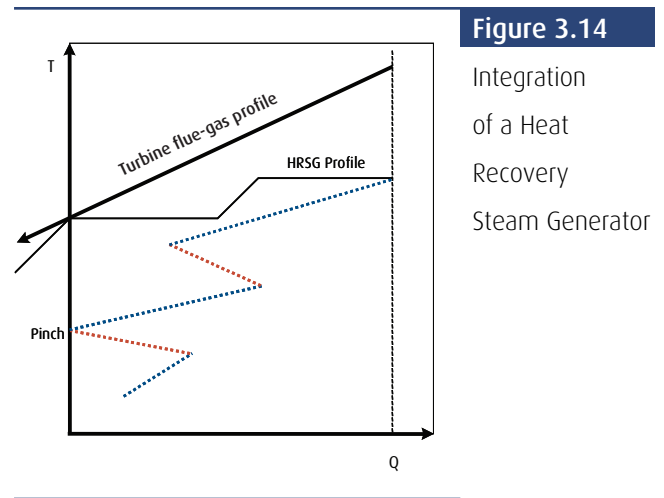

In the opposite situation, when the process requires more heat/steam than is available from the flue gas coming out of the gas turbine, an afterburner may be required to increase temperature levels at the exhaust of the gas turbine. The spent air issuing from the turbine still contains oxygen and may be fed through a second burner in order to supplement the heat available in the exhaust gases.

Large petrochemical facilities and refineries usually depend on a centralized utility system for the provision of steam and power. Site-wide applications of pinch analysis enable the operators to optimize a complete site while considering the demands and opportunities from each process unit. The basics on site-wide analysis are described later in this section.

Heat pumps

Heat pumps, such as vapour compression and refrigeration, are systems that absorb heat at a low temperature in an evaporator, consume shaftwork to compress the working fluid, and reject heat at a higher temperature in a condenser (sorption heat pumps are also available but are not discussed in this guide). The condensed fluid is expanded and partially vaporizes. The cycle then repeats. The working fluid is usually a pure component, which means that evaporation and condensation take place isothermally.

As is the case for cogeneration, there are two ways to integrate a heat pump with a process. If the pump is located completely above the pinch, it simply transforms a set amount of power into heat; however this is never economical. If it is placed completely below the pinch, the situation is even worse as work is transformed into waste heat. The only appropriate way to place a heat pump is across the pinch, where heat is absorbed below the pinch (net heat source) and rejected above the pinch (net heat sink) (as shown in **Figure 3.15**). The performance of the heat pump depends on the temperature lift; the smaller the lift, the better its performance. The relative cost of power to utilities will ultimately dictate the benefits of integrating a heat pump with the process.

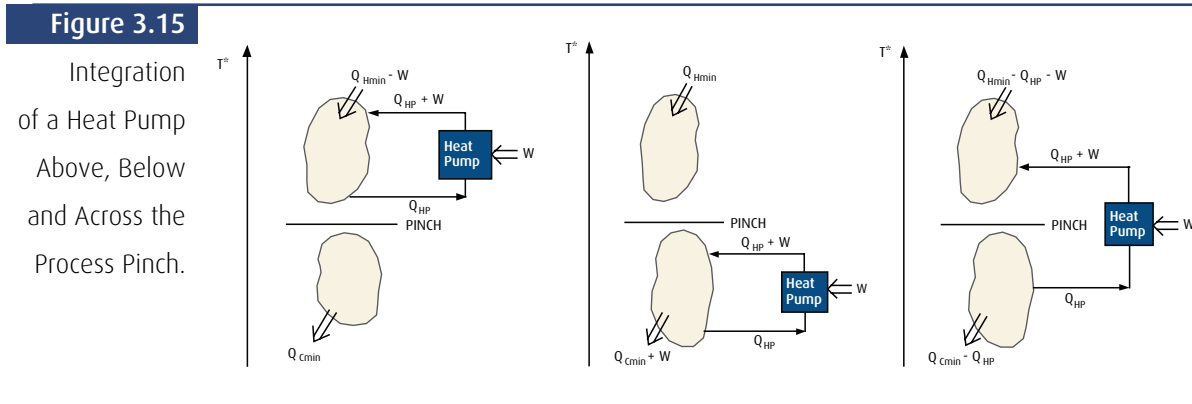

Process modifications: general principles

The minimum energy requirements set by the composite curves are based on a given process heat and material balance. Targets and projects identified by using the composite and grand composite curves are based on these fixed process conditions, i.e., the projects will not have any effect on the fundamental energy requirements and process temperatures of unit operations. Only the method of providing the energy and temperature level can be modified (e.g. energy recovery instead of live steam injection).

In this context, **process modifications** are changes to these conditions. By modifying the balance, it is possible to further reduce the process utility requirement. There are several parameters that may be reviewed, such as distillation-column operating pressures and reflux ratios, feed vaporization pressures, pump-around flow rates, reactor conversion, etc. These process parameters will impact on process temperatures and duties. The aim here is to identify the parameters that can be utilized to improve heat recovery.

The number of choices is so great that it would be extremely time-consuming to conduct an exhaustive search to confidently identify the three or four parameters that, if changed, would benefit of the overall process. However, we can apply thermodynamic rules based on pinch analysis to identify the key process parameters that may have a favourable impact on energy consumption. The approach generally used to identify process modification opportunities is called the “plus-minus principle.”

Process modifications: the plus-minus principle

The heat and material balance of the process determines the shape of the composite curves. As we change the heat and material balance, we change the composite curves, and consequently, the possible amount of heat recovery.

In general, the hot utility target will be reduced by:

- Increasing hot stream (heat source) duty above the pinch;
- Decreasing cold stream (heat sink) duty above the pinch.

Similarly, the cold utility target will be reduced by:

- Decreasing hot stream duty below the pinch;
- Increasing cold stream duty below the pinch.

This is termed the plus-minus principle for process modifications. This simple principle provides a reference for any adjustment in process heat duties, and indicates which modifications would be beneficial, and which would be detrimental. Often, it is possible to change temperatures instead of heat duties. It is clear from the composite curves that temperature changes confined to one side of the pinch will not have any effect on the energy targets. However, temperature changes *across the pinch* can change the energy targets. For example, reducing a stream vaporization pressure (cold stream) may move a vaporization duty from above to below the pinch. As a result, the process energy target can be reduced by the amount of the vaporization duty because waste heat is available below the pinch.

Thus, the pattern for shifting process temperatures can be summarized as follows:

- Shift hot streams from below the pinch to above.
- Shift cold streams from above the pinch to below.

The design procedure for maximum heat recovery

So far in this section, the basic concept of pinch analysis and its associated benefits have been described in sufficient detail to demonstrate that, for complex processes, this approach should be an important part of an energy-saving study or process design procedure.

Once the ΔT_{\min} has been selected, the composite and grand composite curves have been built, and the energy targets computed, the PI practitioner has to build the heat exchanger network that will allow this target to be reached in practice.

As stated before, the pinch point is determined by the minimum temperature difference that will be accepted throughout the network, and divides the problem in two separate systems: one above, and one below the pinch. The system above the pinch requires a heat input and is therefore a net heat sink. Below the pinch, the system rejects heat and so is a net heat source.

There are three basic rules for achieving the minimum energy targets for a process:

- Heat must not be transferred across the pinch (except if a heat pump is used).
- There must be no cold utility used above the pinch.
- There must be no hot utility used below the pinch.

Breaking any of these rules will lead to cross-pinch heat transfer, which would result in an increase in the energy requirement beyond the target (see *Figure 3.6*). In other words, the difference between current energy use and the target is the sum of all cross-pinch inefficiencies. The target can therefore be achieved by eliminating cross-pinch heat transfer.

Flexibility in the design procedure

Using this design approach, the pinch practitioner will be able to identify a number of process improvements that will reduce overall energy consumption. However, successful guidelines must have some flexibility. A design that fully conforms to all pinch rules may well contain uneconomically small heat-exchangers, and may introduce unnecessary complexity to the design.

The key to success, therefore, is to use these rules as an initial framework, which provides guidelines and general directions, but to be prepared to accept some inefficiency for economic or operational reasons. Pinch software is available to assist the engineer in developing a good heat exchanger network that satisfies the pinch rules for most streams and heat exchangers. The use of software is particularly important in retrofit situations where the current configuration needs to be taken into account.

The pinch engineer needs to select which plant inefficiencies may be tolerated to reduce capital costs and to maintain maximum flexibility for plant operations.

Often, a number of energy-saving targets need to be set during the course of the work. The starting point is the minimum energy target calculated from the initial composite curves; however, as the work develops, it may be necessary to revise the composite curves to reflect process modifications (identified through the plus-minus principle), unacceptable heat exchange matches (safety, operability, layout), and other practical constraints.

An important feature of pinch analysis is that, at this stage of the project, each one of these targets has associated capital and energy costs (see the section on the selection of ΔT_{\min}). Therefore, any change made to the composite curves during the course of the work has a quantifiable financial benefit or penalty. A focused discussion is necessary to decide whether these changes should be accepted or not.

All in all, pinch analysis may be considered a powerful aid to process design, provided it is regarded as a series of design guidelines, always pointing in the direction of improvement. In that way, even with some iteration, it can save engineering work hours during the design process by eliminating, at an early stage, non-productive work directions.

It is also important to recognize that the design of a successful energy-recovery network requires combining pinch expertise with process knowledge.

Site-wide analysis

When considering a number of processes on a single site, it is vital to include the interactions between the processes and the utility system. For large sites, where direct heat integration between processes (e.g. heat exchange between two streams from different processes), is difficult due to distance, or where processes must remain de-coupled, indirect integration may be achieved through the utility system. This generally takes the form of steam production (from heat recovery) in a process for use in other processes via the steam mains (see **Figure 3.16**). The site-wide analysis technique presented in this section can be a very powerful approach for oil refining, petrochemical, and iron & steel plants. In general, the pinch analysis techniques presented in the previous sections are sufficient for facilities in other industrial sectors, and site-wide analysis techniques are rarely applied in those sectors.

Figure 3.16

Schematic of a Site Operating Several Processes Linked Indirectly Through the Utilities.

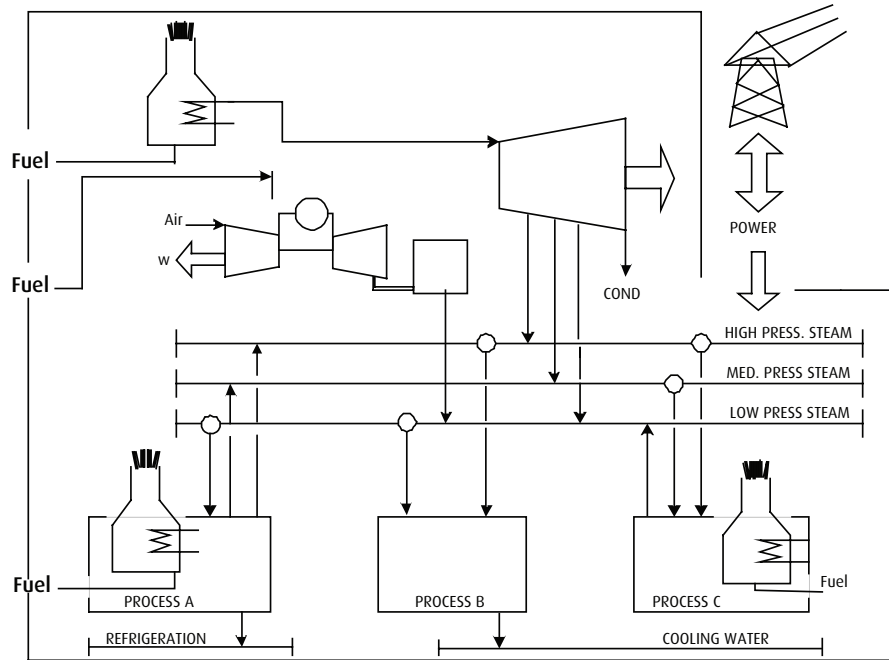

Site-wide analysis usually starts with a kick-off meeting, during which the level of detail appropriate to each on-site process is defined and agreed upon by the plant's management and the pinch expert. In general, not all processes need to be analyzed at the same level of detail due to any of the following:

- Lack of data in some units;
- Major investments in some plants ruled out for business reasons (age of plant, declining sales, etc.);
- Small size or low complexity of the process does not warrant detailed study;
- Not achieving maximum heat recovery within processes can often be compensated for by relatively easy inter-process integration.

Subsequently, a scoping phase of the work establishes an appropriate model to represent each operating plant. These models are then combined to produce a site-wide overview. There are three broad categories of detail level that may be applied to any process:

1. Black box processes (consider the overall utility consumption only)

These processes are not to be analyzed in detail. This may be because their energy consumption is very small, because heat recovery projects may be difficult to implement, or because the company is just not prepared to invest in that area. A full pinch analysis is considered inappropriate for these processes, and they are represented simply with their existing utility consumption profile. For example, if a process presently consumes 1 t/h of 3-bar steam, its hot utility demand is represented as 600 kW at 134°C, equivalent to the heating value of the steam.

2. Grey box processes (consider only heat transfer that involves utilities)

These processes have minimal scope for process-process heat exchange, but have significant utility use. In these cases, only the process-utility heat exchangers are included in the analysis. The analysis goes a step further than it does for the black box processes. It might, for example, recognize the fact that the 3-bar steam is actually being used to heat ambient air in a dryer to a temperature of 80°C. In this case, the demand for hot utility may be characterized as 600 kW (the same overall heating duty as for the above black box), but now distributed over a temperature range of 10°C to 80°C (the actual process temperatures). This then opens up the possibility of replacing the 3-bar steam with, perhaps, a hot water loop or even by process waste heat from another process.

The remaining process streams that are heated or cooled by utility are considered in a similar way; however, process-process heat exchange matches are not considered. In this way, the process/utility interface can be optimized, subject to site-wide considerations instead of internal optimization within the process. Again, individual plant pinch analyses are considered to be inappropriate.

3. White box processes (perform a detailed pinch analysis)

These are complex processes with significant energy consumption. In these processes, a full pinch analysis is carried out to determine the scope for in-process optimization. Conventional composite curves are constructed, and grand composite curves are derived from them to identify the target (or optimum) consumption of each hot and cold utility.

The profile of the grand composite curve above the pinch temperature represents a demand (or sink) for heat and the profile below the pinch temperature represents a surplus (or source) of heat in that particular process.

These source and sink profiles of the individual process grand composite curves (white box processes) are extracted together with the black box, and the grey box streams (only those heated or cooled by utilities), into source and sink curves representing the combination of processes. In a site-wide analysis, the process heat sources are shown in the diagram on the left, and the process heat sinks are shown in the diagram on the right (for the entire site, not only for one process, as for the composite curves). *Figure 3.17* presents this idea for four processes where a detailed pinch analysis was deemed to be useful and where a certain number of additional processes are represented by grey or black box models as discussed above.

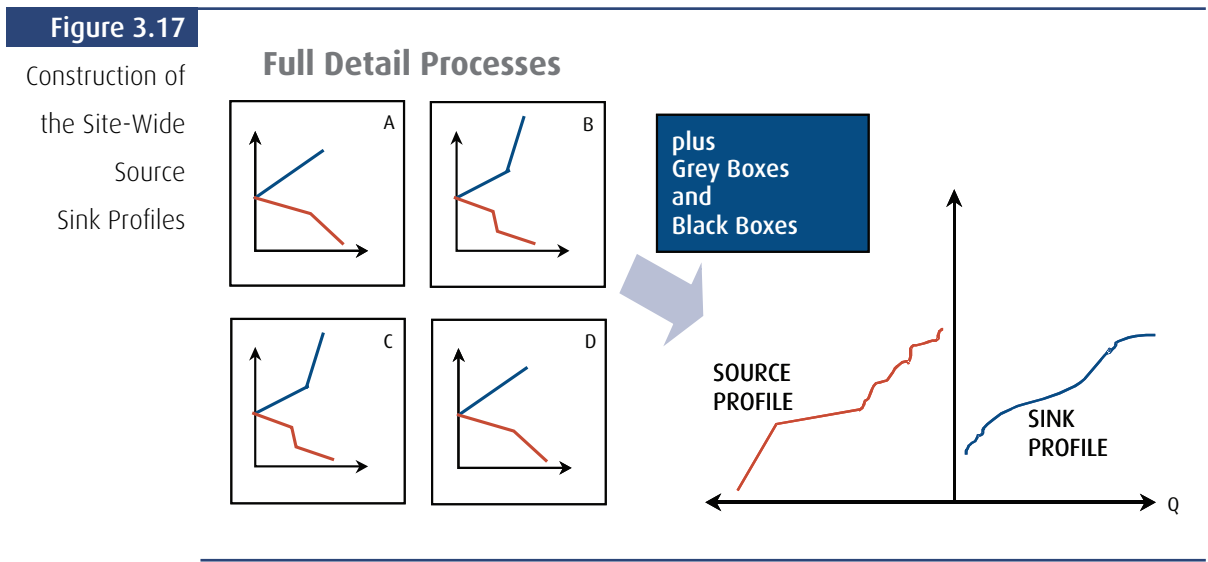

This is not the same as simply combining all the stream data for the various processes into a single data set. That would allow for every conceivable integration possibility across the site, usually a far from realistic scenario—constraints such as distances, controllability, flexibility, etc. reduce the number of possible matches to recover heat between two processes.

The construction described above recognizes the autonomy of each individual process and, by separating source and sink curves, only allows inter-unit integration via an intermediate utility. What is important is that all site utility demands are included in the site curves in some form or another. It is only the level of detail with which these demands are represented that changes according to the fact that they are related to a white, grey or black box process.

Site-wide analysis is used to determine the potential for maximizing indirect integration. The analysis will identify:

- The optimum balance of process steam generation (via heat recovery) and consumption;
- The optimum steam header pressures for maximum heat recovery.

Superimposing the current utility balance onto these curves graphically shows where lies the potential to improve the utility balance. For example, in **Figure 3.18(a)**, the gap between the Process Heat Sources curve and the Existing Steam Generation Profile shows that there is potential to generate additional high-pressure steam from process heat recovery. Similarly, the gap between the Process Heat Sinks curve and the Existing Steam Consumption Profile shows that much of the current medium-pressure steam consumption can be switched to low-pressure steam.

Figure 3.18(b) shows the target for optimum steam generation (through heat recovery) and the target for optimum steam consumption (heat load and pressure levels) for the same example. It is important to note that the total heat demand has not changed. The same heating demands are being placed on the utility system as before (blue curve). However, on the process source side (red curve), additional steam generation potential has been identified, effectively increasing the heat integration between the processes and reducing the needs for hot utility. The integration would have to be achieved indirectly, through the utility system.

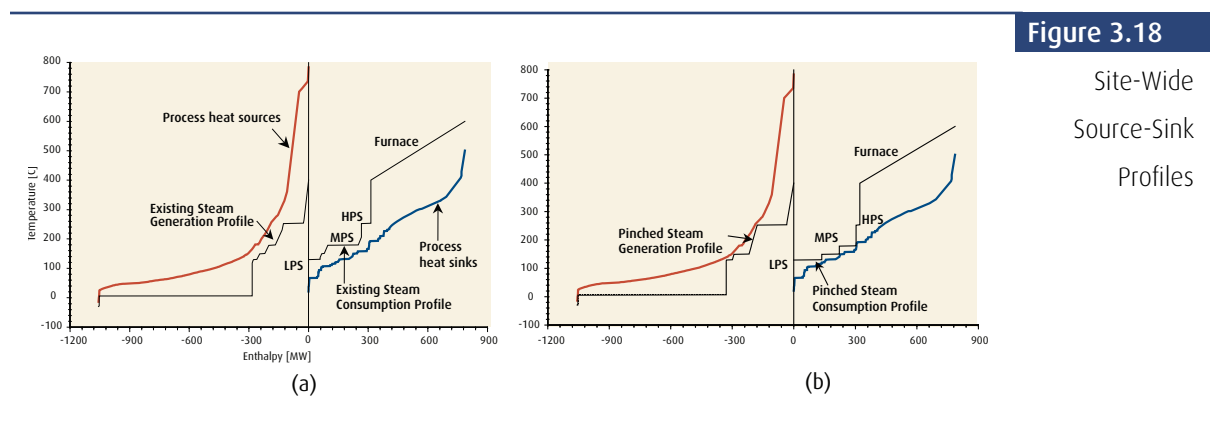

The optimization of steam levels only has significance in a grassroots design, or if the different levels are generated from the exhaust of steam turbines. In the above example, generating additional high-pressure steam would result in much more generation than consumption. To achieve savings, therefore, the high-pressure steam would have to be passed through a turbine to generate a lower-pressure steam at a level where there is a demand while generating power.

A site-wide study is typically carried out in two phases, as shown in *Figure 3.19*.

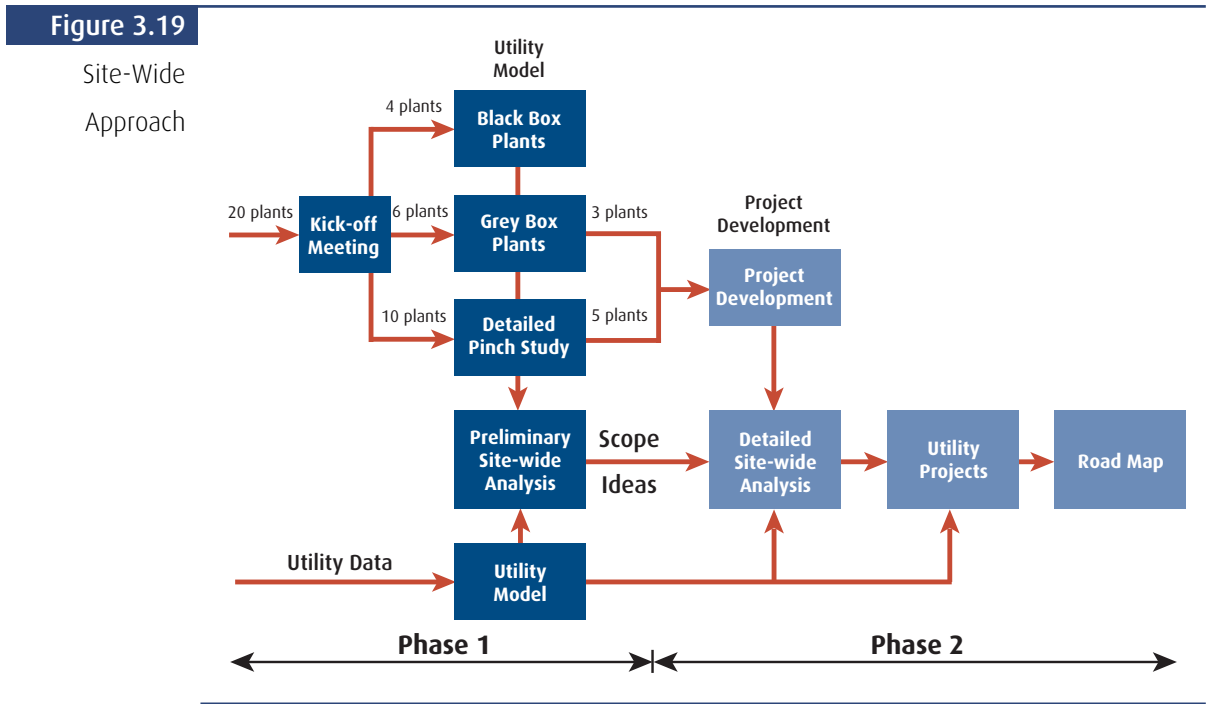

Phase 1: targeting

The objective of Phase 1 (shaded blue boxes) is to calculate a target for minimum site energy consumption, and to identify, on-site, the key processes offering the greatest scope for savings.

The on-site processes are first categorized as black-, grey-, or white-box processes, depending on complexity and scope for energy savings.

For each white-box process, the scope for energy savings is defined using composite curves. This determines whether heat recovery projects will be developed in greater detail within these processes during Phase 2 (projects will be developed if the potential for energy savings, i.e., the difference between the current energy consumption and the target, is significant). Finally, site targets are determined using the site source-sink profiles presented in this section (*Figure 3.18*). These targets determine whether or not projects of indirect heat integration, between the processes (via the utility system), will be developed in Phase 2.

A model of the site utility system is also developed in order to determine the effect of proposed projects on the overall balance of fuel and power (Figure 3.20). For example, this model will allow us to evaluate how much steam will go in each turbine with the associated power production, and how much steam will pass through a let-down station.

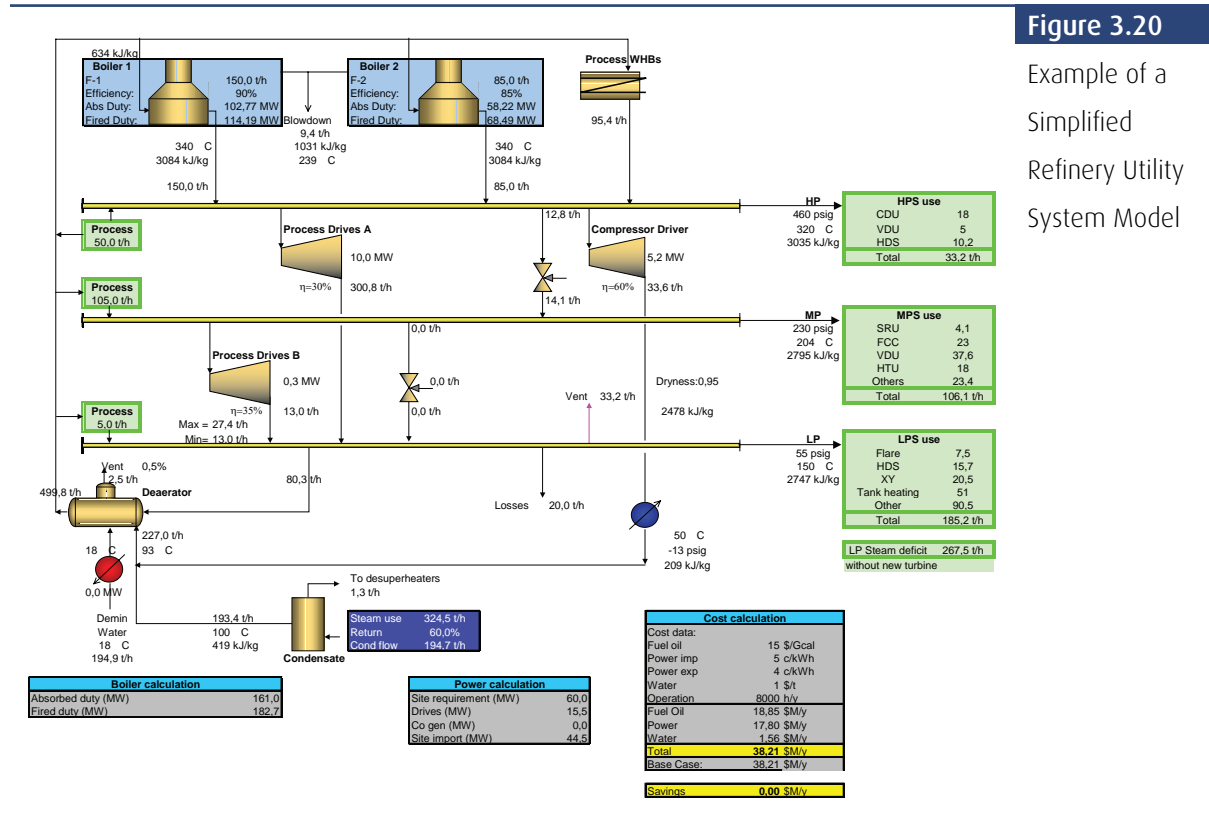

This approach allows project development to focus where it is likely to yield the greatest benefits.

The deliverables of Phase 1, therefore, are:

- A reliable target for overall, site-wide savings;
- Identification of the areas in which work must be concentrated during project development.

In this way, engineering hours are minimized both in Phase 1, through a judicious use of black and grey boxes, and in Phase 2, by not having to study every area in detail.

Phase 2: project development

The objectives of Phase 2 (blue boxes in *Figure 3.19*) are the development of project packages that meet prevailing investment criteria, and the construction of a strategic investment road map. The road map includes project details such as savings, investment, effect on emissions, and the compatibility of projects with each other. It forms a rigorous basis for the long-term site planning of all energy-related issues.

The site-wide analysis technique presented above is generally referred to as total site analysis. Some software applications based on this approach are currently available. Other site-wide analysis techniques are currently under development (notably a technique known as Top Level Analysis), and should be available within the next few years.

3.3 Water pinch

Over the past two decades, there has been a change in attitudes to the environmental impact of industrial operations. Governments have introduced new legislation and established regulatory authorities with increased powers to enforce compliance.

Today, reducing waste has become one of the greatest challenges facing process industries. Because wastewater is one of industry's major waste products, the ability to reclaim wastewater for reuse is an important step toward overall waste reduction.

Identifying and deploying the best water reuse systems is a challenge. Modern technologies present a myriad of confusing alternatives that the engineer must consider.

Water pinch is a systematic technique for analyzing water networks and identifying projects to increase the efficient use of water in industrial processes. Advanced applications make use of advanced algorithms to identify and optimize the best water reuse, regeneration (partial treatment of process water that allows its reuse), and effluent treatment opportunities.

The most important driver to performing a water pinch study is reducing flows to the wastewater treatment plant, and avoiding capital expenditures in new plants. Simple savings in freshwater and wastewater are unlikely, on their own, to justify the cost of carrying out a detailed water pinch study and implementing the recommended projects. However, as with energy, water pinch analysis should be regarded as a natural part of new process design, and incorporated into normal design procedures. Interesting insights into an optimized process design will always result when we bear in mind the best matching of sources and sinks by paying attention to water quality.

Water pinch may be applied to almost any industrial water system where there are users of fresh water and producers of wastewater. The technology is capable of analyzing even the most complex water systems, and has been successfully applied in a number of industrial sectors.

Significant water and wastewater reductions have been achieved by applying water pinch in various industries. Savings of 25 to 40% have been observed in the following industries: oil refining, chemicals, pulp & paper, and food & drink.

Of course, achieved savings greatly depend on project objectives. Good solutions that are identified with water pinch often do more than save water. They tend to reduce capital investment, recover valuable raw materials, and sometimes, recover heat.

This section gives an overview of the concepts underlying water pinch analysis and its approach to water conservation and wastewater minimization. Further details may be found in the references at the end of the guide.

Parallels to energy pinch

For a number of years, process integration techniques based on pinch analysis have been successfully applied to improving energy efficiency in the process industries. Analogous techniques have now been developed for water conservation and wastewater minimization.

Many of the familiar tools of energy analysis appear in a water pinch analysis. **Figure 3.21** shows the composite curves for a single contaminant, representing water sources (water stream rejected by an equipment or process), and water sinks (water required at the inlet of each process or equipment). Whereas, in an energy analysis, the curves plot temperature and heat duty, here, water flow rate is represented on the horizontal axis (quantity) and water purity is represented on the vertical axis (quality). The source-sink curves are therefore also referred to as “purity profiles.” These composite curves represent the overall water sources (flowrate and concentration) available on the site, and the water sinks required by the entire process. The data required to build these curves are the flowrate and the contaminant concentration for every significant water stream of a plant. The Sources curve in **Figure 3.21** has three water streams (1, 2 and 3), and each is characterized by its flowrate and concentration (e.g. stream 1 has a concentration of 200 PPM and a flowrate of 38 l/s). Each stream is located on the curve from the most contaminated to the cleanest. Vertical segments are then drawn between streams in order to get a continuous curve. The Sinks curve is built in a similar way and is then moved from the right side of the graph toward the Sources curve until both curves touch at the pinch.

Figure 3.21

Water Purity Profiles

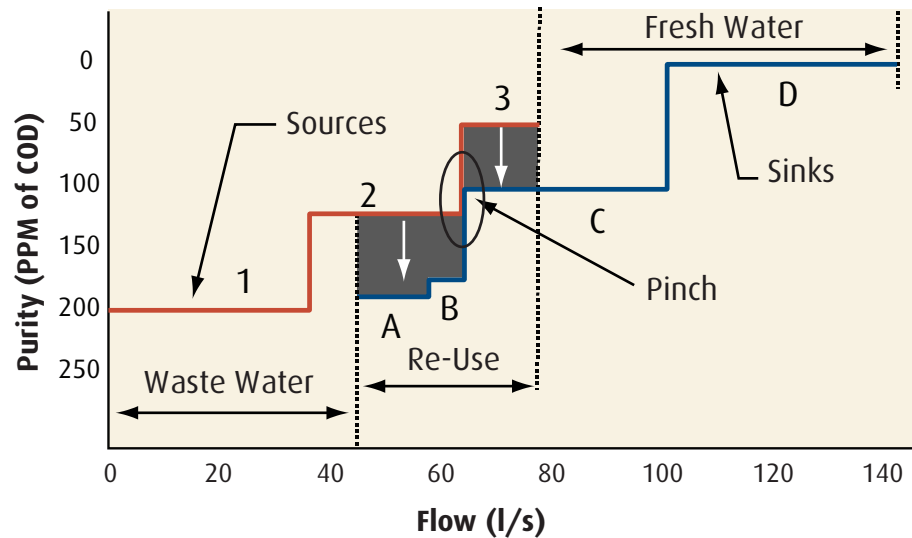

The overlap between the Sources curve and the Sinks curve indicates the scope for water reuse, and is limited by the pinch point where the two curves touch. Where there is no overlap, the profiles represent the freshwater consumption (on the right) and the wastewater generation (on the left).

To reduce the freshwater consumption and the wastewater generation of the plant, it is possible to mix some source streams (e.g. Sources 2 and 3 in **Figure 3.21**) in order to satisfy the requirements of Sink C. By doing this, the pinch point is removed, allowing the Sinks composite curve to slide below the Sources composite curve toward the left, until a new pinch point limits the displacement of the Sinks curve (**Figure 3.22**). The overlap between the Source and Sink curves has increased, indicating that more process water can be reused within the process, thereby reducing the requirements for freshwater intake and wastewater treatment.

To reduce freshwater consumption even further, Sources 1 and 2 (**Figure 3.22**) may be mixed in the appropriate proportion to satisfy the requirements of Sink A, while Sources 2 and 3 may be mixed again to satisfy a greater part of Sink C. This process may be repeated until it is not possible to move the Sinks curve further toward the left. At that point, the overlap between both curves indicates the maximum amount of water that can be reused without treatment, while the extremities of the figure show the minimum freshwater consumption and wastewater generation targets. These targets are similar to the minimum cooling and heating requirements in energy pinch.

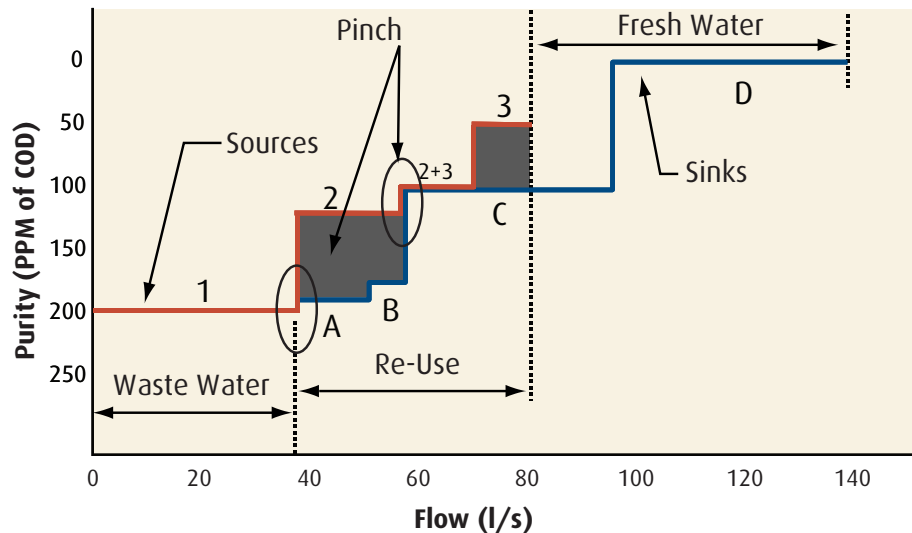
**Figure 3.22**

Mixing Streams to Reduce Freshwater Consumption and Wastewater Generation

Multiple contaminants

So far, the water pinch approach has been presented for one contaminant; however, industrial water streams generally contain several contaminants.

In principle, purity profiles need to be developed for each contaminant. Each contaminant will have an ideal design that meets its specific flow rate target. Each of these targets will be different, and so will the designs.

As a practical matter, the designs have to be merged into a common piping network that performs well for all components. At that stage, graphical approaches become iterative and tedious. A mathematical programming formulation is therefore used to optimize trade-offs and provide a single piping-network design that will minimize system cost via water reuse, subject to quality and quantity constraints. Software applications based on this approach are available on the market.

Sensitivity analysis

This is one of the most powerful tools of water pinch analysis. Unlike composite curves, which are two-dimensional plots of flow and concentration, contaminant sensitivity analysis is a result of multi-contaminant analysis.

Usually plotted as bar graphs (Figure 3.23), sensitivity analysis indicates where increases in *maximum acceptable inlet concentration* to a given process or equipment can yield the largest savings. These are the processes where engineering efforts should be concentrated. It also gives a clear message about the non-sensitive processes: ignore them; cost savings will be insignificant. Using the example in Figure 2.23, accepting water with a higher contaminant concentration in Column F would significantly reduce operating costs for the overall water network while the effect would be negligible in Column A.

Figure 3.23

Sensitivity Plots

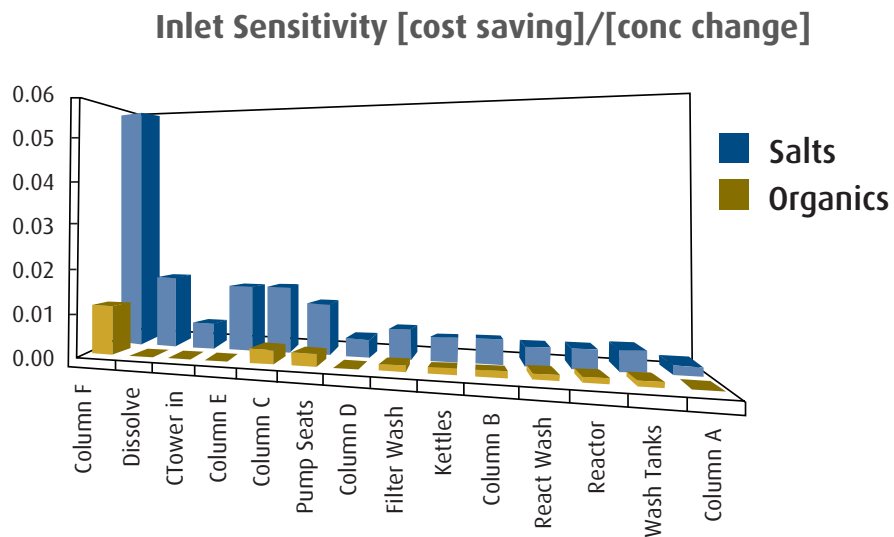

A similar sensitivity analysis may be performed on the *process outlet water concentrations*. In this case, the analysis will indicate which streams are appropriate for regeneration before being reused.

These plots are valid for a given water network. Changes to the structure will change the sensitivity of the various areas. During the design of the water network, we can therefore use this sensitivity analysis several times, i.e., each time a modification is made to the network.

Types of water reuse possibilities

During the course of a water pinch study in an industrial facility, several types of water reuse solutions, with or without water treatment, are successively investigated:

1. A water pinch study begins with the assumption that existing inlet concentrations (concentration of water sinks) are at their maximum acceptable limits for all site processes/equipments. This indicates the minimum water usage under currently imposed constraints on inlet concentrations. Projects identified at this stage will be low-cost opportunities involving only pipework modifications, but generally allowing only small water **reuse** opportunities.
2. We take this a step further by using sensitivity analysis to identify projects where large water savings are possible. This is done by *increasing the upper concentration limits* to selected sinks (**Figure 3.24**). The challenge, when we relax these inlet concentration constraints, is to identify the maximum acceptable level of contamination for each unit operation. Thus, discussions between plant operators and engineers are essential in order to evaluate the risk of quality or corrosion problems. In some cases, external process experts, data from manufacturers, as well as feasibility studies will be required.

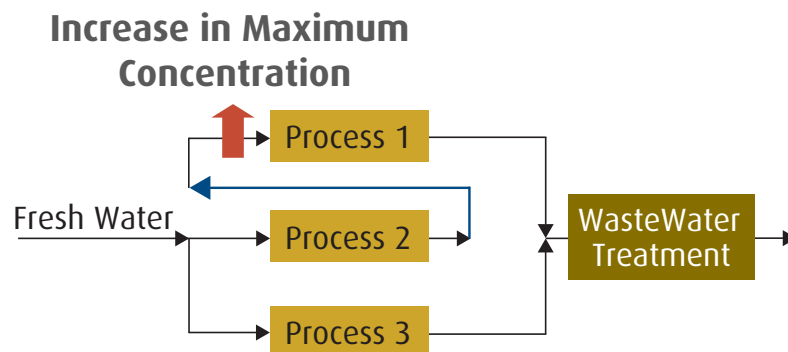

Figure 3.24

Water Re-use
with Changes
to the Inlet
Concentration

Projects to modify the water network are mostly defined at this stage. They mainly involve simple piping modifications, but will normally lead to significant water savings.

3. The next step after evaluating reuse options is to determine the potential offered by the many different combinations of *regeneration and reuse* projects. These projects consist in partially treating some process water streams before their reuse (**Figure 3.25**). First, we identify the key streams for possible treatment in a regeneration process. Both existing and new water treatment units can be evaluated in terms of reducing overall water consumption. Projects identified at this stage will involve capital expenditure for localized treatment steps.

Figure 3.25

Water
Regeneration
and Re-use

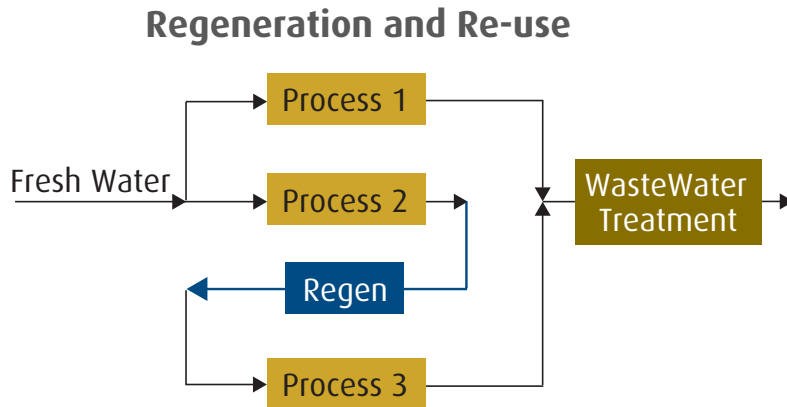

4. The final step is the evaluation of *distributed effluent treatment* options. Instead of mixing all waste streams together and treating them in a single treatment plant, streams may be segregated in function of the contaminants they contain, and treated appropriately before mixing with other streams (Figure 3.26). In this way, several small-scale treatment units will operate on undiluted effluent streams, rather than one large unit operating on very dilute effluent.

For example, if Process 3 rejects very contaminated water in terms of contaminant A but relatively clean water in terms of contaminant B, while Process 2 rejects very contaminated water in terms of contaminant B but slightly contaminated water in terms of contaminant A, then the distributed water treatment system presented in Figure 3.26 may be a good option for reducing system operating and capital costs. Treatment Process 1 (TP1) should then be very efficient for removing contaminant B, while Treatment Process 2 should be very efficient for removing contaminant A.

Distributed effluent treatment systems are interesting options as they often offer better removal efficiency at reduced cost.

Figure 3.26

Distributed
Effluent
Treatment

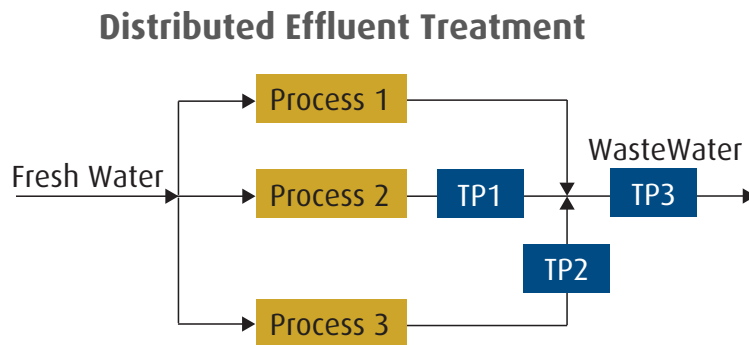

A typical water pinch study

A typical water pinch study is carried out in three phases.

Phase 1: water balance

For any study, it is essential to have a reconciled water and contaminant balance, as well as information on future plans and objectives for the site, such as production increases.

The main features of Phase 1 are:

- Existing balances should be validated, or new balances developed if required.
- Any conflicts in available data should be identified and resolved. Commercial software applications are available to identify incoherent data in a site water balance. If required, additional measurements for water flows and contaminant concentrations should be performed.
- The location of main effluent streams should be identified, as well as their associated problems, and the key contaminants.

Phase 2: water pinch analysis

The objective of Phase 2 is to identify the maximum scope for water system savings and to highlight key areas for future projects.

The main steps of this phase are presented in greater detail in the previous section, and are illustrated in **Figures 3.24** to **3.26**. They consist in:

- Identifying the minimum freshwater target for fixed operating conditions;
- Identifying the minimum freshwater target when an increase in the maximum acceptable inlet concentrations is allowed in some processes/equipments;
- Identifying the minimum freshwater target when some process water streams can be regenerated and reused;
- Performing a preliminary analysis on the possibilities for distributed wastewater treatment;
- Analyzing projects identified in the previous points;
- Performing a more detailed analysis of wastewater treatment options and identifying the appropriate technologies, such as membranes or biological treatment systems.

Phase 3: project identification & road map

The objective of this phase is the full evaluation of project ideas identified in the previous phases, and the development of a strategic investment road map detailing alternative project recommendations and their associated savings.

The main deliverables of Phase 3 are:

- Project definition package, including schematics of proposed modifications plus expected savings;
- Conceptual design (excluding detailed engineering such as pipe and pump sizing, material selection, etc.);
- Creation of a road map to indicate investment strategy, together with realizable benefits. For example, **Figure 3.27** shows the possible investment strategies following a study aiming at reducing the wastewater flowrate and its contamination level through water reuse and distributed effluent treatment systems.

Figure 3.27

Example of a Road Map to Reduce Overall Costs for a New Wastewater Treatment System

Investment Strategy Road Map

TP = Treatment Plant

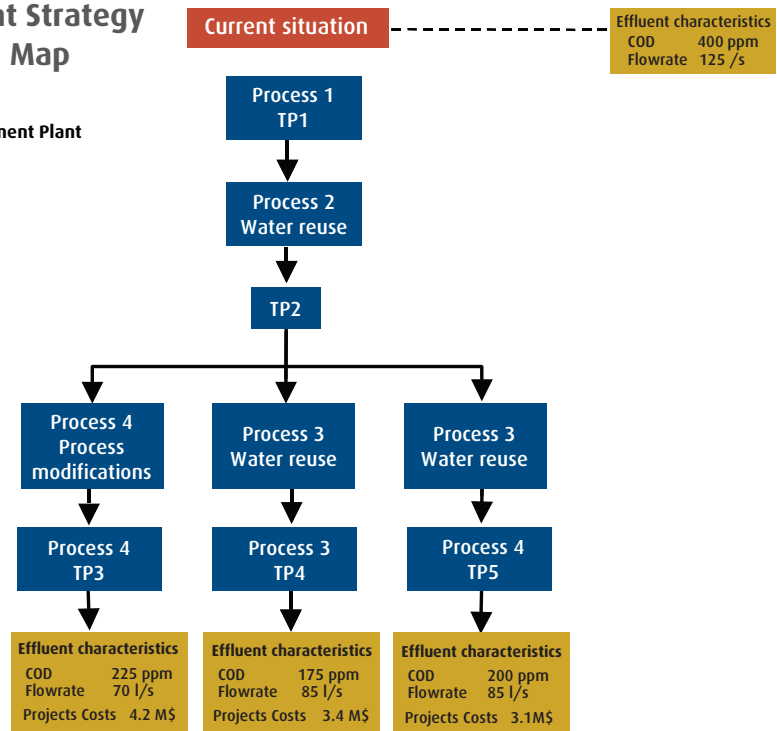

3.4 Hydrogen pinch

Recent developments in environmental legislation, as well as market forces are pressuring the refining industry to change. Legislation to reduce sulphur in products, markets shifting toward lighter fuels, and an increasing drive to use heavier, sourer crudes all mean that refinery operations will have to adapt to remain profitable.

The demand for hydrogen is increasing, both to supply the additional hydrotreating capacity required to produce lower sulphur products from heavier, sourer crudes, and to process lighter fuel products from cracking processes. Simultaneously, some refineries are reducing naphtha reforming in order to meet aromatics limits. A consequence of this is reduced hydrogen generation. Aside from having to consider new processing capacity, a consequence of these changes is that the hydrogen balance is shifting, as the hydrogen offer and demand has significantly changed over the past years.

For many refiners faced with the unwelcome choices of having to invest in new processing capacity, import more expensive crudes, or lose yield on valuable products, the questions then arise:

- What can be achieved with existing equipment?
- What would be the pattern of investment necessary to maintain profitability?
- Is it possible to take advantage of the new market possibilities resulting from changes in legislation?

To rebalance supply with demand, investments are widely planned for new hydrogen plants and hydrogen recovery units.

A lower cost alternative is hydrogen management. The hydrogen pinch approach can incorporate the economics of hydrogen supply, process yield, and capital investment, resulting in practical and economically viable solutions that meet the new specifications required of today's refineries. The approach identifies the optimum hydrogen network, which maximizes processing revenue in terms of hydrogen system operating costs and production benefits, while minimizing capital investment. As a further benefit, minimizing operating costs also reduces CO₂ emissions.

Typical savings from hydrogen pinch analysis are as follows:

- hydrogen demand up to 20%
- hydrogen system operating costs up to 15%
- capital avoidance up to 15%
- CO₂ emissions up to 160 kg per 1000 barrels of crude

This section briefly describes the concepts at the heart of hydrogen pinch analysis, as well as its application to improve process yield, reduce hydrogen system operating costs, and minimize capital investment. Further details may be found in the references at the end of this guide.

Parallels with energy and water

Analysis of hydrogen systems is conceptually very similar to the methods of energy pinch and water pinch. Both hydrogen and water systems are networks of fluid flows that may be defined in terms of flowrate and purity. As a result, the definition of hydrogen composite curves is done in a very similar way to that described for the energy or water pinch. We are plotting quality versus quantity. The curves are a plot of flowrate on the horizontal axis, and purity on the vertical axis (in the case of a gas mixture composed of several gases, the purity represents the fraction of hydrogen in the gas mixture).

Again, in an analogous way to energy curves, the scope for reuse is defined by the overlap of the composites for source (flowrate and purity of hydrogen streams coming out of processes) and sink (flowrate and purity of hydrogen streams required at the inlet of processes), and is limited by the pinch point where the curves touch (**Figure 3.28**). The target for minimum pure hydrogen makeup (from a hydrogen plant or from import) is given by the horizontal difference between the curves at the high purity end (right of the composite curves). The minimum purge rate is defined by the horizontal difference between the curves at the low purity end (left of the composite curves). In the case of hydrogen systems, the purge is generally fed to the site fuel gas main.

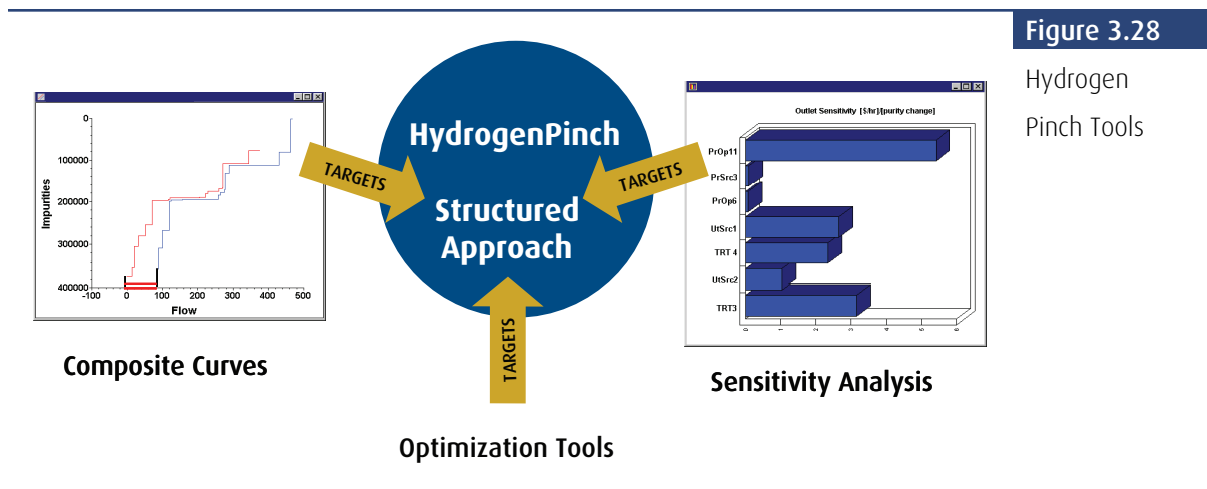

A number of significant factors differentiate hydrogen systems from energy and water systems:

- **Cost**—because of the high cost of hydrogen and hydrogen generation equipment, systems are usually highly integrated, with significant reuse of purge gas;
- **Pressure**—because hydrogen is a gas, compression costs are high, and therefore, pressure is an important parameter in the overall economics of the system;
- **Effect of purity on production**—because hydrogen purity influences the economics of refinery unit operation in terms of throughput, yield or run length.

These factors are difficult to represent graphically. For this reason, mathematical optimization tools, similar to those used for water, are applied to optimize hydrogen systems (*Figure 3.28*). However, these tools have been extended to incorporate additional parameters, in order to maximize profitability (simultaneously addressing hydrogen system, operating costs and process benefits), and minimize the investment required to achieve that profitability.

Sensitivity analysis

Sensitivity analysis is also a powerful tool to help optimize hydrogen networks (*Figures 3.28* and *3.29*). Its emphasis, however, is different from that used in water systems. In water studies, the aim is to identify the users for which a decrease in feed purity (i.e., processes/equipments that can accept water with a higher contaminant concentration) has the largest impact in reducing overall system operating costs. While the technique may be applied to hydrogen systems in this way, it is uncommon to find any refinery unit where a decrease in hydrogen feed purity is acceptable. As discussed above, this potentially has a significant impact on processing and, therefore, profitability. It should be noted, however, that, in particular cases, large and viable benefits have been found by debottlenecking hydrogen systems on this basis.

Figure 3.29

Hydrogen Pinch
Sensitivity
Analysis for
Several Units
of a Refinery

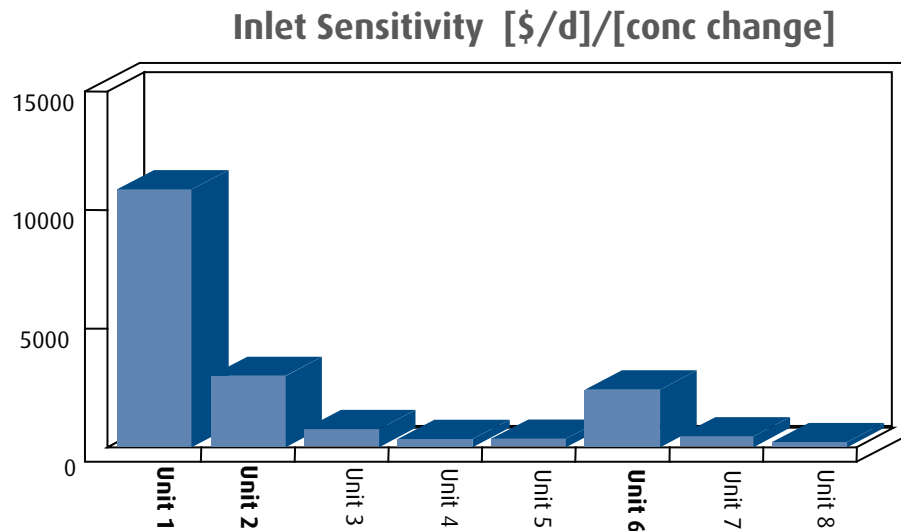

The application of *inlet sensitivity analysis* to hydrogen systems is normally performed to identify the units where an increase in feed purity is the most profitable (purer hydrogen can produce benefits on production, but there is a cost to obtain this higher purity considering the purity and pressure levels available on the site). This approach potentially has the largest overall benefit in terms of hydrogen cost and production improvements.

A sensitivity analysis applied to *unit outlet purities* aims at identifying units where an improvement in separation within the process would provide purer hydrogen for reuse in other processes at a minimal cost.

A typical hydrogen pinch study

A hydrogen pinch study is typically divided into a number of phases. Because of the nature of the approach, the phases are defined according to the different possible study aims (e.g. reducing refinery hydrogen system costs, improving hydrogen management in refinery processes, highlighting potential for capacity debottlenecking, improving energy efficiency and environmental impact). For example, Phase 1 may look at optimizing the existing operation, while Phase 2 evaluates the best investment strategy for a future scenario.

Depending on the study objectives, the analysis may be separated in four targeting stages, beginning with the optimization of the existing operation, to the evaluation of the best investment strategy for a future scenario:

- **Target 1: base case optimization**

This target is constrained to the existing network of connections. The aim is to identify no- or low-cost improvements that can be made in the hydrogen balance. Since existing systems are often well integrated, this target may be regarded as an optimization of that network. In general, savings identified at this stage are small, but serve to establish a base case for the remainder of the work.

- **Target 2: minimum investment**

Targeting at this stage aims to identify low-cost modifications, such as piping changes. Existing “idle” equipment, such as compressors or purification units, may also be included at this stage in the analysis.

- **Target 3: new equipment**

This target is less constrained than the first two, in that more complex modifications and significant investment items are considered. Apart from large piping changes, this target will identify and evaluate the benefits of new compressors, new purification units, and new hydrogen generation plants.

- **Target 4: process modifications**

At this stage, changes to process conditions are considered (for processes that are net hydrogen producers, and processes that are net hydrogen consumers). This often results in the greatest benefits being identified, but can also represent significant investments.

The approach outlined above structures the investigation according to an approximate investment scale: Target 0 corresponds to no/low investment, while Targets 3 and 4 potentially represent the largest capital investment. This forms the basis of an investment strategy road map, which details project savings and investments.

Applying pinch analysis to optimize hydrogen management in a refinery requires the use of hydrogen management software and an extended experience in refining processes. To our knowledge, no hydrogen pinch software is currently available on the market (September 2003). Specialist consultants, who offer this type of service, have usually developed their own software.

REFERENCES

Publications in the area of Process Integration are numerous. The list that follows does not necessarily refer to the latest work in the area of PI but presents in more details the concepts presented in this Guide.

Books and Guides

Gundersen, T., *A Process Integration Primer*, International Energy Agency - Implementing agreement on process Integration, 2000.

Linnhoff, B. *User Guide on Process Integration for the Efficient Use of Energy*, The Institution of Chemical Engineers, UK, 1994.

Rossiter, A. P., *Waste Minimization Through Process Design*, McGraw-Hill, 1995.

Smith, R., *Chemical Process Design*, McGraw-Hill, 1995.

Publications and Conferences

Dhole, V. R. and Linnhoff, B., *Total site targets for fuel, co-generation, emissions and cooling*, in 'ESCAPE II', Toulouse, France, 1992.

Dhole, V.R., Tainsh, R.A., Wasilewski, M., Ramchandani, N., *Make your Process Water pay for itself*, Chem Eng, 103, 21, 1996

Hallale, N. and Liu, F., *Refinery hydrogen management for clean fuel production*, Advances in Environmental Research 6, 81-98, 2001.

Klemes, J., Dhole, V. R., Raissi, K., Perry, S. J. and Puigjaner, L., *Targeting and Design Methodology for Reduction of Fuel, Power and CO₂ on Total Sites*, Applied Thermal Engineering 17(8-10), 993-1003, 1997.

Wang, Y. P. and Smith, R., *Wastewater Minimization*, Chemical Engineering Science, Vol. 49, No. 7, pp. 981-1006, 1994.

Wang, Y. P. and Smith, R., *Wastewater Minimization with Flowrate Constraints*, Trans IChemE, Vol. 73, Part A, pp. 889-904, 1995.

Thesis

Alves, J. *Analysis and Design of Refinery Hydrogen Systems*, Ph.D. Thesis, UMIST, 1999.

Raissi, K. *Total Site Integration*, Ph.D Thesis, UMIST, UK, 1994.



The CanmetENERGY research centre of Natural Resources Canada works at developing and promoting knowledge and technologies in the field of energy. Its mission consists in assisting key sectors of the Canadian economy in their sustainable development efforts and more particularly to reduce their greenhouse gas emissions and make a rational use of energy.

CanmetENERGY in Varennes

1615, Lionel-Boulet Blvd., P.O. Box 4800, Varennes, Quebec, J3X 1S6, Canada

Phone: (450) 652-4621 | Fax: (450) 652-0999 | Web Site: <http://canmetenergy.nrcan.gc.ca>



Natural Resources
Canada

Ressources naturelles
Canada

Canada