



---

# PLANNING & DECISION GUIDE FOR SOLAR PV SYSTEMS

Procedure for Solar Designers, Builders and their Design Teams  
to Quickly Define Solar PV Requirements

---



Developed by Natural Resources Canada's  
Local Energy Efficiency Partnerships (LEEP) team.

[NRCan.LEEP.RNCan@Canada.ca](mailto:NRCan.LEEP.RNCan@Canada.ca)

## Acknowledgements:

British Columbia builders used LEEP to identify common PV knowledge gaps and challenge experts to propose solutions. The resulting series of presentations were delivered at LEEP Technology Forums and then through webinars provided by the Canadian Home Builders Associations (CHBA). These presentations were the impetus for the development of this guide. It was built from a foundation that also includes NRCan's existing Photovoltaic Ready Guidelines.

NRCan thanks all those that contributed to the review or trial of the guide including: Bfreehomes, Bluewater Energy, Building Knowledge, the Net Zero staff at CHBA, Doug Tarry Homes, and Switch Energy.

This guide was developed by Ben Giudici of Riverside Energy Systems and Terry Strack of Strack and Associates. Its development was managed by Alastair Larwill from the LEEP team at CanmetENERGY. Funding for this work was provided by Natural Resources Canada through the Green Infrastructure Program.

Front cover image: Solar photovoltaic array consisting of polycrystalline-cell modules. Photograph courtesy of Riverside Energy Systems.

## Disclaimer:

*The aim of this publication is to provide solar consultants, home owners, home builders and their design and construction teams with a framework for making decisions together on the types of photovoltaic systems to use in residential building projects.*

*Natural Resources Canada assumes no liability for injury, property damage, or loss from using information contained in this publication. This guide is distributed for informational purposes only and does not reflect the views of the Government of Canada nor constitute an endorsement of any commercial product or person.*

Cat. No. M154-135/2020E-PDF

ISBN: 978-0-660-35861-1

Aussi disponible en français sous le titre: **GUIDE DE PLANIFICATION ET DE DÉCISION POUR LE CHOIX DES SYSTÈMES DE PANNEAUX SOLAIRES PV**



## Table of Contents

INTRODUCTION:.....	1
Integrated Design and Construction Team: .....	3
Design Flexibility when integrating Solar PV.....	5
STEP 1: Builder Preference for Solar PV Integration .....	6
STEP 2: Utility Connection Requirements and Constraints at the Build Site .....	9
STEP 3: Confirming Solar PV Integration Design Requirements .....	14
STEP 4: Defining Annual PV Energy Production Target .....	19
STEP 5: Defining Solar PV Array Location(s) and Size(s) .....	21
STEP 6: Electrical Impacts and Point-of-Connection Methods .....	24
STEP 7: Structural Impacts and PV System Attachment Methods .....	27
STEP 8: Preferred Solar Module Technology.....	30
STEP 9: Preferred Solar Inverter Technology .....	33
STEP 10: Energy Monitoring Approach.....	36
APPENDIX A: Common Solar PV Questions and Clarifications for Builders.....	38
APPENDIX B: Solar PV System Integration Worksheet .....	45

## Table of Tables

Table 1: Integrated Design Team Makeup based on the Solar PV Option selected by the Builder .....	7
Table 2: Checklist of Various Project Requirements for the Different Solar PV Integration Options.....	8
Table 3: Planning Matrix of Design Requirements for Solar PV Integration at a Build Location .....	15

## Table of Figures

Figure 1: Overview of the Planning and Decision Process for Integrating Solar PV at a Build Site .....	2
Figure 2: Solar PV System Integration Worksheet .....	3
Figure 3: South Roof Dormer Limits South Facing Solar PV.....	5
Figure 4: South Dormer Removed in Favour of 3 kWp PV Array .....	5
Figure 5: Defining Overall Planning Requirements for Solar PV integration at a Build Location.....	6
Figure 6: Electrical Configuration for Feed-in-Tariff .....	10

Figure 7: Electrical Configuration for Net-Metering and Net-Billing.....	10
Figure 8: Example of Two-Tiered Rate – BC Hydro Residential Conservation Rate, April 2019 .....	11
Figure 9: Electrical Configuration for Net-Zero Electricity Connections.....	11
Figure 10: Electrical Configuration for Self-Use.....	12
Figure 11: Electrical Configuration for an Off-Grid Solar PV System.....	12
Figure 12: Net-Metering Solar PV system with Bi-Modal Inverter.....	13
Figure 13: Planning Matrix of Basic and Optional Requirements for Solar PV integration at a Build Location .....	14
Figure 14: Roof Mounted PV System using South and West Facing Arrays.....	21
Figure 15: Outdoor Leisure Area Solar PV shelter.....	22
Figure 16: Residential Solar PV Parking Shelter.....	22
Figure 17: Residential Wall-mounted Solar PV system.....	22
Figure 18: Ground-mounted Solar PV Array.....	22
Figure 19: Example of Self-Induced Array Shading by Roof Gable .....	23
Figure 20: Feed-in-Tariff Point-of-Connection .....	25
Figure 21: Main service panel Point-of-Connection .....	25
Figure 22: Intended 15 kWp System Limited to 10 kWp by Electric Service Panel Choice.....	26
Figure 23: Service Splitter used as Point-of-Connection .....	26
Figure 24: Lag Bolted Anchors to Blocking between Trusses: - Sub-structure (top); Flashed Anchors with Racking (bottom).....	28
Figure 25: Flashed Anchors screwed to Roof Decking, with racking attached .....	28
Figure 26: Racking Attachment to Standing Seam Metal Roofing.....	29
Figure 27: Example of a Flat Roof Ballasted Solar PV Array.....	29
Figure 28: Example of a Polycrystalline-cell module.....	30
Figure 29: Example of a Monocrystalline-cell module.....	30
Figure 30: 3.5 kWp Array using Monocrystalline-Cell, All-Black Modules.....	31

Figure 31: Two Bi-facial Solar Modules-back surface shown on left, front surface shown on right.....	31
Figure 32: Solar Railing using Bi-Facial Modules.....	31
Figure 33: String Inverter with Dual MPPT Channels - Shaded Operation.....	33
Figure 34: Optimized String Inverter - Shaded Operation.....	34
Figure 35: Microinverter – Shaded Operation.....	35
Figure 36: Example of a Basic In-house Energy Display .....	36
Figure 37: Example of an advanced energy display showing solar energy production and energy consumption for daily and monthly time periods .....	37
Figure 38: 6 kWp PV System AC Output Power, Aug 26, 2019.....	40
Figure 39: 6 kWp PV System Output Power, Aug 23, 2019.....	40
Figure 40: Solar Access and Shading Analysis - Contrasting Two Sites.....	41
Figure 41: Solar PV Array Orientations - Azimuth and Tilt Angle .....	42
Figure 42: Red Deer AB, Effects of Azimuth and Tilt on Annual Solar PV Energy Production.....	43

[This page has been left intentionally blank]

# INTRODUCTION:

## Purpose

The **Planning and Decision Guide for Solar PV Systems** (“GUIDE”) is intended for use by solar PV consultants / installation contractors, together with their home builder and home owner clients, to assist them in integrating solar PV technologies into residential applications.

## Scope

The focus of this GUIDE is on solar PV-ready and solar PV-installed applications in the residential sector.

### **This guide covers the following applications of Solar PV technology:**

- Solar PV-Ready installations in new homes, including net-zero ready homes;
- Solar PV Installations in existing and new homes, include net-zero homes;
- Grid-connected systems, as well as off-grid applications of solar PV;
- PV systems without batteries, as well as battery-ready and battery-installed applications.

### **This guide covers the following technologies:**

- Modular solar PV panels, based on either poly-crystalline or mono-crystalline silicon cells, including all-black and bi-facial modules;
- Solar PV inverter technologies, including string inverters, optimized-string inverters, micro-inverters, and bimodal inverters.

### **Exclusions include:**

- Specific application requirements for Building Integrated Photovoltaic (BIPV) products are not covered in this guide.
- Planning for specialized requirements needed for community-wide solar PV installations, (e.g., use of centralized energy storage facilities, etc.) falls outside the scope of this guide.

## Why Builders need the GUIDE

Builders need this GUIDE to:

- Provide a framework to ensure important, project-specific needs are met, which could improve performance, affordability, and value of the new home.
- Reduce project risks and costs by identifying key design team members and their perspective roles to ensure solar PV technology is integrated seamlessly into the design and construction processes.
- Leverage efforts, by transferring “lessons-learned” from one GUIDE-design process to all other houses in the development.

When builders offer solar PV options on their new home, they:

- Demonstrate forward thinking to potential buyers;
- Create additional value per building lot;
- Provide long-term, sustainability benefits that can be marketed to potential buyers.



## Why Solar PV consultants need the GUIDE

Solar PV consultants need this GUIDE to:

- Facilitate discussions and collaborative decision making with their clients.
- Ensure builder's and home owner's solar PV goals and expectations are met.
- Proactively advise builders and project design teams of on-site constraints and design issues to ensure solar PV is as effective as possible.
- Support builders in ensuring that solar PV-ready or solar installation steps integrate into the overall construction schedule as seamlessly as possible.

## The GUIDE in action

Residential solar photovoltaic (PV) systems can bring significant value to any residential project. Most Canadian grid-connected solar PV systems are designed with the modest goal of reducing grid electricity use to some extent. Some projects have the more ambitious goal of achieving Net-Zero Energy (NZ) or Net-Zero Electricity performance using grid-connected solar PV. Interest in NZ performance has grown in recent years due to increasing motivation for energy efficiency and sustainable building performance.

This GUIDE is to be used by a builder to assemble and direct their team to meet the solar goals established for the project. It provides the context and framework to gather the right people to facilitate a holistic discussion between the integrated design team, and the builder or home owner.

An overview of the solar PV system planning and decision process is shown graphically in Figure 1.

The process consists of 10 steps which can be grouped into four major parts:

- I. Pre-Design Considerations (STEPS 1 to 3)**
  - *Builder preference for solar integration*
  - *Assembling the integrated design team*
  - *Utility connection requirements and constraints at the build site*
  - *Confirming overall project scope and requirements*
- II. Solar PV Integration Design Requirements (STEPS 4 to 7)**
  - *Annual PV Energy Production targets*
  - *PV array and area requirements*
  - *Electrical impacts and connection methods*
  - *Structural impacts and solar PV attachment methods*
- III. Preferred Solar PV Component and Monitoring Equipment Types (STEPS 8 to 10)**
  - *Preferred solar module technology*
  - *Preferred inverter technology, and*
  - *Preferred energy monitoring approach, if required*
- IV. Integrated-Build Hand-off of Specifications and Requirements to the Construction Team**

*Refer to Appendix A, Question 1 for additional details on hand-off requirements as the project transitions from the design-phase to the construction-phase.*

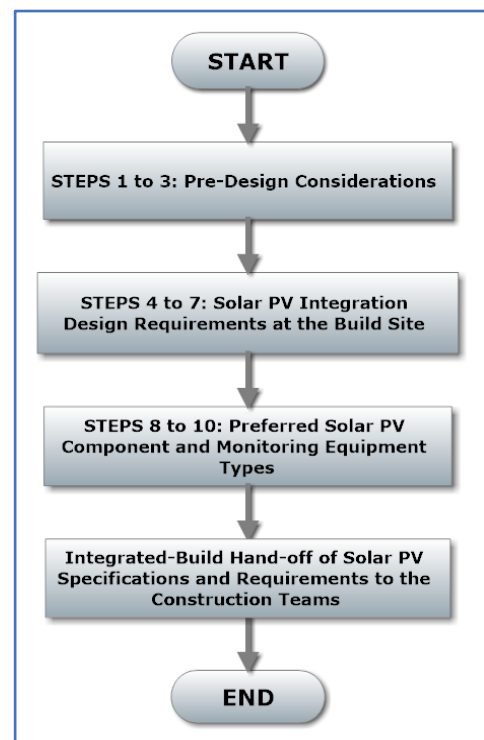

Figure 1: Overview of the Planning and Decision Process for Integrating Solar PV at a Build Site

# Solar PV System Integration Worksheet

A two-page worksheet is included with the GUIDE (as Appendix B), or as a separate PDF download and is shown in Figure 2.

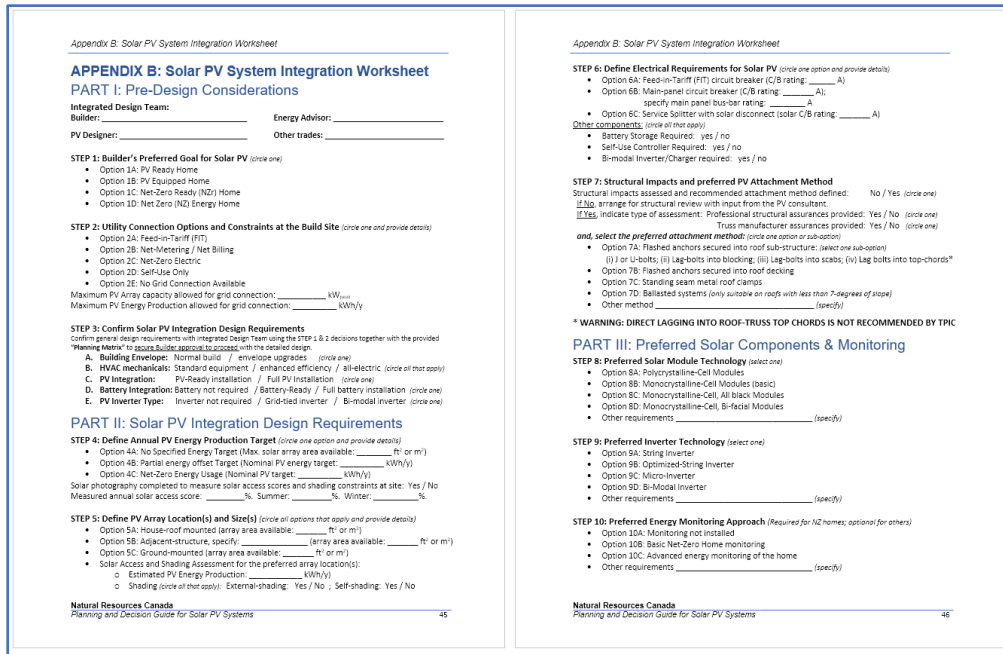

Figure 2: Solar PV System Integration Worksheet

This worksheet can be used in one of two ways:

1. Together with the Solar PV Guide as a summary sheet to record decisions made while working through the ten steps using the full GUIDE documentation.
2. As a stand-alone worksheet that experienced users can review options and record decisions, referring to the full GUIDE documentation only when additional information is required.

## Additional technical resource

NRCan's **Photovoltaic Ready Guidelines** is an excellent resource for builders integrating solar PV into their plans. It provides technical information on optimal roof angles and orientations as well as typical distances for roof set back, utility room space requirements, as well as solar conduit requirements. This document should be use as a supplemental guide to this GUIDE, but it does not replace the expertise of an experienced solar consultant.

Use your web browser to search for “**NRCan PV Ready Guidelines**” to download a free copy.

## Integrated Design and Construction Team:

This GUIDE is to be used in an integrated design process. The decision process should be completed with appropriate consultants before construction has commenced so that the builder can integrate the required changes in an orderly fashion, thereby reducing risk and optimize cost-efficiencies of integrating solar PV into their high-performance home.

Each specialist has a specific team role in ensuring the success of a solar integrated build and contributes during the planning and construction phases to ensure project success.

### **Builder/architect:**

- Identifies solar goals.
- Presents building plans.
- Selects level of design flexibility

### **Solar consultant (PV consultant):**

- Identifies solar PV annual energy production required to meet project goals.
- Identifies annual and monthly solar access scores, and shading constraints using solar photographic site assessment.
- Reviews plans and identifies possible changes required to meet solar PV energy production goals.
- Provides annual solar PV energy production projections through appropriate modelling.
- Identifies local utility requirements, determines suitable solar PV options and maximum grid connectivity allowance for the project.
- Ensures electrical service equipment capacity and design are appropriate for PV system size contemplated, advises builder and electrician of solar PV electrical requirements in advance of electrical service installation, and updates electrical plans.
- Updates building plans to show physical locations of solar PV arrays, inverter(s), disconnection means, and point-of-connection to the grid.
- Specifies suitable solar PV racking and attachment methods for review by builder, truss designer and structural engineer as deemed necessary by the Authority Having Jurisdiction (AHJ).

### **Truss designer and structural engineer:**

- Ensures structural loading and attachment requirements are suitable for the solar PV installation.
- Updates structural and solar PV attachment requirements on plans.

### **Registered energy advisor (EA):**

- Provides the building energy model.
- Identifies projected building annual energy (i.e., electricity and fossil-fuel) consumption.
- Identifies possible envelope and/or equipment energy-efficiency enhancements to reduce solar PV generation requirements.

### **HVAC design consultant**

- Provides room-by-room, heating and cooling design loads used for equipment and duct sizing.
- Provides detailed duct design plans to deliver energy-efficiency and comfort, and recommendations for window selection and framing changes to minimize mechanical system impacts on interior space and aesthetics.
- Provides guidance on required capacity of heating and cooling equipment based on design loads.

### **Electricians, Plumbers, HVAC contractors, Framers and Roofers:**

- Provide helpful feedback on changes made to the plans.
- Accommodate solar PV electrical requirements during service equipment selection and installation.
- Provide solar PV electrical raceways between present or future array locations, solar inverter(s) and disconnection means, and the point-of-connection to the grid.
- Accommodate unobstructed solar PV areas through collaborative roofing strategies, and careful placement of vents, plumbing stacks, etc.

## Design Flexibility when integrating Solar PV

The solar consultant must know the extent to which their design suggestions can be accommodated in order to give relevant advice. Solar should be considered in the planning and design stages to ensure best outcomes for the client.

This is especially important if the builder is looking to achieve a Net Zero Ready (NZr) designation or a Net Zero (NZ) designation for their building. Changes might be needed to ensure that generation (or potential generation) can meet the energy consumption of the home to achieve the NZ or the NZr designation. If design changes are not possible the builder may not meet their solar production goal.

Solar PV consultants may suggest changes to improve solar PV outcomes which could include altering:

- Layout of the community when multiple buildings are involved;
- Roof pitch, orientation, style, or membrane type;
- Placement of vents, skylights, chimneys, and/or other rooftop features;
- In collaboration with truss designer or structural engineer, structural components to accommodate additional loads from solar arrays;
- Size and placement of electrical service equipment and raceways to accommodate solar infrastructure and electric utility requirements;
- Removal or topping of problematic shade trees to improve solar access scores;
- Placement of solar PV arrays to locations other than the house rooftop.

Design changes leading to reduced building electrical consumption and reduced solar PV system requirements could include:

- Envelope insulation levels;
- Air tightness targets;
- Mechanical system selection;
- Appliance and lighting selections.

### Design Flexibility Example

During the integrated design process for the home shown in Figure 3, installation of a solar PV system was a high priority for the builder. However, the only south-facing roof section was occupied by a decorative dormer. Review showed that removing the dormer would allow for installation of a south facing 3 kWp solar PV array as shown in Figure 4. The avoided dormer construction expenses helped offset the cost of the solar PV installation; a win-win design choice.



Figure 3: South Roof Dormer Limits South Facing Solar PV  
– courtesy of Sonbuilt Homes



Figure 4: South Dormer Removed in Favour of 3 kWp PV Array  
– courtesy of Sonbuilt Homes

## STEP 1: Builder Preference for Solar PV Integration

When integrating solar PV technology into a house design, it is necessary to consider both:

- Builder preference for solar PV integration (covered in STEP 1);
- Local electrical utility requirements for grid-connected PV systems (covered in STEP 2).

As illustrated in Figure 5, the results from these two decision STEPS will provide valuable information to the builder and their “Integrated Design Team” by defining basic and optional components of the house build and PV technology that need to be considered when integrating solar PV at the build location.

- Recommendations on the makeup of the Builder’s “Integrated Design Team” are provided at the end of STEP 1.
- The “Planning Matrix” is defined and discussed in STEP 3 of the GUIDE.

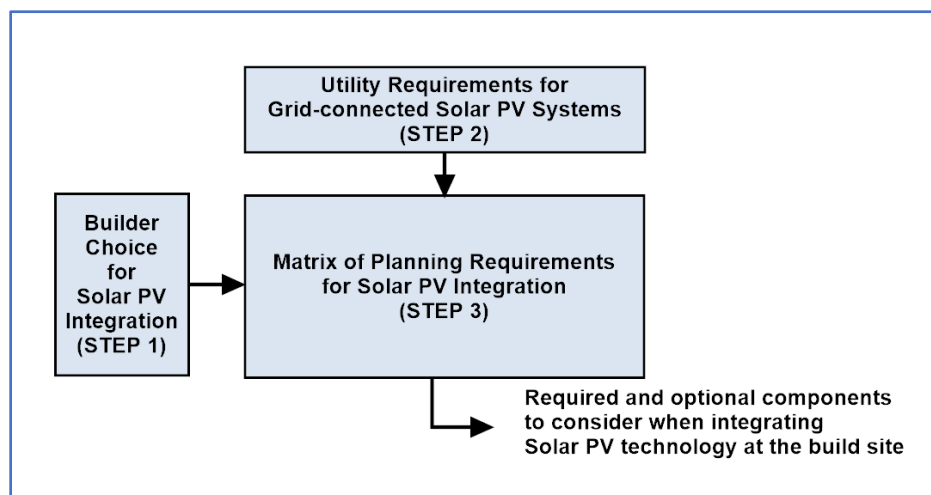

Figure 5: Defining Overall Planning Requirements for Solar PV integration at a Build Location

Builders have four possible options to consider:

### Option 1A: PV Ready Home

Builders may want to take the first step toward solar integration by simply providing the basic infrastructure needed for a solar PV installation at a later date [1]. Making a home Solar PV Ready can reduce the future cost to the homeowner of installing a solar PV system.

### Option 1B: PV Equipped Homes

Builders might want to begin by offering a solar PV system as a package onto their current build to offer homeowners additional choice.

In this case a solar PV system can be sized to offset part or all of the homeowner’s estimated electrical usage, or provide the homeowner with a revenue source from their new home, depending on the utility connection option available at the home’s location.

## Option 1C: Net Zero Ready Home

The builder may be looking to achieve a Net Zero Ready (NZr) designation, by enhancing the energy performance of the building envelope and mechanical systems in the home, and providing the basic infrastructure needed for solar PV installation at a later date [1].

Net Zero Ready houses are designed with building envelopes that have modelled annual heating energy consumption that is at least 33% lower than reference houses at standard mechanical conditions. They also have designated areas for solar PV of sufficient capacity to produce enough energy to offset the total energy consumption of the proposed house on an annual basis [2].

## Option 1D: Net Zero Energy Home

The builder may be looking to distinguish themselves, or better serve their clients, by building a Net Zero (NZ) Energy home.

Net Zero Energy houses are designed with building envelopes that have modelled annual heating energy consumption that is at least 33% lower than reference houses at standard operating conditions. They also have installed solar PV systems of sufficient capacity to produce enough energy to offset the total energy consumption of the house on an annual basis [2].

In some jurisdictions, electrical utility regulations may restrict the type of mechanical equipment that can be utilized in a NZ house design. Please refer to Appendix A, Question 5 for additional information.

## Integrated Design Team Considerations

Regardless of the choice for solar PV integration, best project outcomes depend on having an integrated design team collaborating and working together early in the design process to establish a common understanding of how solar production goals will be met.

The team members in Table 1 are recommended for builders who are integrating solar PV for the first time in a housing project. Ultimately the builder can decide which members they wish to include in their integrated design team.

Table 1: Integrated Design Team Makeup based on the Solar PV Option selected by the Builder

Team member	Builder Option for Solar PV Integration			
	1A: PV Ready Home	1B: PV Equipped Home	1C: Net Zero Ready Home	1D: Net Zero Energy Home
Builder / architect	✓	✓	✓	✓
Solar consultant	✓	✓	✓	✓
Truss designer/ structural engineer	✓	✓	✓	✓
Registered Energy Advisor			✓	✓
HVAC consultant			✓	✓
Utility representative (for connection requirements)		✓		✓

## Requirements for Different Solar PV Integration Options

In addition, Table 2 lists the various project requirements to consider for each of the builder options for solar PV integration.

Table 2: Checklist of Various Project Requirements for the Different Solar PV Integration Options

Project Requirements to Consider	Builder Option for Solar PV Integration			
	1A: PV Ready Home	1B: PV Equipped Home	1C: Net Zero Ready Home	1D: Net Zero Energy Home
Have raceways, conduits, or cables installed to accommodate solar PV installation	✓	✓	✓	✓
Have space designated to accommodate additional electrical and solar equipment	✓	✓	✓	✓
Ensure structural readiness for a solar PV array installation now or in the future	✓	✓	✓	✓
Do not place vents, plumbing stacks, chimneys, or other obstacles on roof areas where solar PV arrays are to be located now or in the future (Refer to Appendix A, Q1)	✓	✓	✓	✓
Have a written solar PV (PV-ready) report presented at closing to the home owner to help them understand (or navigate) the solar PV installation (at a later date)	✓	✓	✓	✓
Secure a complete copy of the solar PV-ready/NZr report and design documentation to wall space allocated for future PV hardware next to the main electrical panel of the home	✓		✓	
Have a site assessment with solar photography to measure solar access scores and shading obstruction impacts		✓	✓	✓
Have a solar PV energy production model based on array capacities, placement, and site assessment		✓	✓	✓
Have an energy model of the home which identifies annual energy consumption			✓	✓
Have adequate designated solar PV array locations to accommodate a solar installation which will generate enough electricity to offset the home's annual energy use			✓	✓
May require changes to envelope design and air tightness, window and mechanical equipment selection to reduce annual energy consumption			✓	✓
Include Solar PV installation steps into the overall building schedule		✓		✓
Have approved connection agreement in place with the local utility		✓		✓
House creates as much energy as it uses over a one-year period				✓

### References

1. NRCan's Photovoltaic Ready Guidelines, Technical specifications, supporting information, and what homeowners can expect from PV-Ready homes, 2017.
2. Canadian Home Builders' Association Net Zero Home Labelling Program, Technical Requirements – Version 1.1, February 1, 2020.

## STEP 2: Utility Connection Requirements and Constraints at the Build Site

The options and requirements for grid connected PV systems vary from jurisdiction to jurisdiction and may change over time. It is important for the builder's design team to understand and consider how possible electrical utility constraints could influence the design of the solar PV system, fuel choices at the build site, and the desired energy performance outcomes for the project.

The solar PV consultant will be familiar with the local utility requirements, and can provide jurisdiction specific guidance during project planning to assist the builder's design team in defining the solar PV system configuration that will best fit with the overall project goals at the specific build location.

Local electrical utilities will typically have:

- Customer generation interconnection guidelines
- Metering requirements
- Rate structures
- Allowable grid connection methods
- Capacity limits on maximum PV array capacity (i.e., maximum inverter kW)
- Maximum PV energy production for grid-connected systems (i.e., maximum allowable kWh exports to the grid)

Allowable PV system size, metering configurations and possible energy self-use limitations will affect Solar PV design decisions, capital installation costs, and desired energy and self-sufficiency outcomes.

Solar PV connections will fall into one of the following categories.

- Option 2A: Feed-in-Tariff (FIT) Connection
- Option 2B: Net-Metering / Net Billing Connection
- Option 2C: Net-Zero Electricity Connection
- Option 2D: Self-Use Only Connection
- Option 2E: No Grid Connection Available / Off-Grid Solar PV System

The first four options are grid-connected solar PV Systems. The last option (i.e., "Option 2E") is applicable to "off-grid" solar PV applications when an electrical utility connection is not possible.

- These five connection options are described in the following sections.
- Battery-Ready and Battery Storage options are discussed at the end of STEP 2.



## Option 2A: Feed-in-Tariff (FIT) connection

With a “**Feed-in-Tariff or FIT connections**”, the home purchases all required electrical energy from the grid while simultaneously selling all PV generated electrical energy into the grid during daylight hours.

- Two utility meters are required; one measuring energy purchased from the grid and the second measuring energy delivered directly from the PV solar system to the grid.
- Solar PV systems generate power into the grid, not into the home.
- Electrical energy purchase rates and FIT energy credit rates will usually be different.

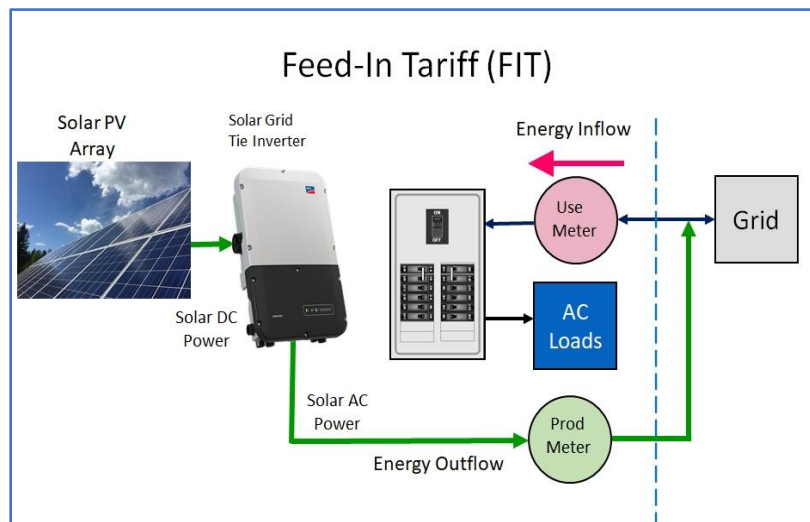

Figure 6: Electrical Configuration for Feed-in-Tariff - courtesy of Riverside Energy Systems with Inverter image courtesy of SMA

## Option 2B: Net-Metering or Net-Billing connection

With “**Net-Metering or Net Billing connections**”, the solar PV systems delivers electrical energy to the home in parallel with the grid.

- A single utility meter is required which separately measures both energy inflow from the grid, and energy outflow to the grid.
- PV power production serves the on-site AC loads first, reducing energy inflow from the grid.
- PV power production in excess of on-site AC loads requirement causes energy outflow to the grid.

With “**Net Metering connections**”, billing is based on Energy Inflow MINUS Energy Outflow.

Under Net-Metering with a multi-tiered rate structure, highest returns on solar PV investment can be realized by sizing PV systems to reduce electrical consumption from the higher priced tiers.

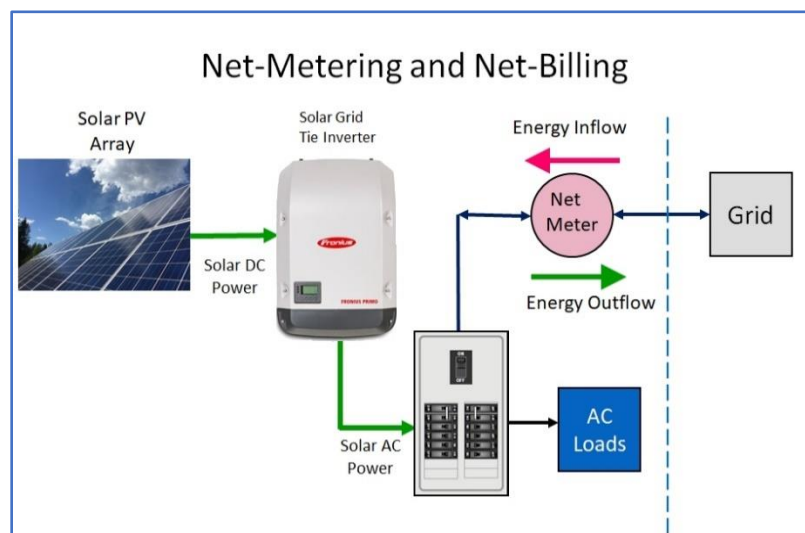

Figure 7: Electrical Configuration for Net-Metering and Net-Billing - courtesy of Riverside Energy Systems with Inverter image courtesy of Fronius

## STEP 2: Utility Connection Requirements and Constraints at the Build Site

For example, with the BC Hydro residential rate structure shown in Figure 8, many PV system designs in BC focus on reducing Step-2 tier energy purchases from the grid. This allows for a lower initial investment with higher rate of return per unit of electricity generated; versus more costly Net-Zero designs, which must offset all grid energy inflow including less expensive Step-1 tier energy.

### TWO-STEP CONSERVATION RATE

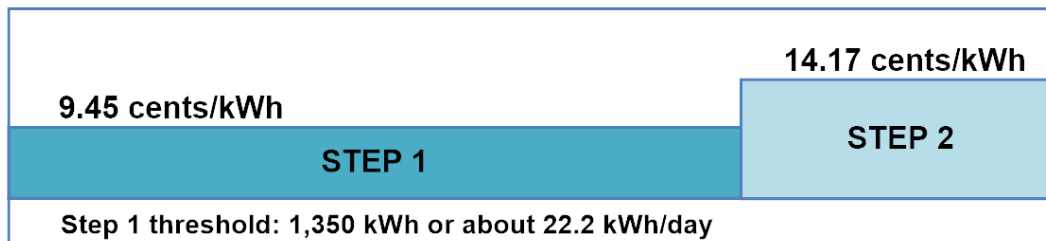

Figure 8: Example of Two-Tiered Rate – BC Hydro Residential Conservation Rate, April 2019

“**Net-Billing connections**” are the same as net-metering connections, with one difference. With net billing, energy inflows and energy outflows are valued at differing energy rates by the utility. Typically, the utility credits energy outflows to the grid at a lower value than energy inflows from the grid to the customer.

## Option 2C: Net-Zero Electricity Connection

“**Net-Zero Electricity Connections**” function in the same way as Net Metering connections with the following restriction. With **Net-Zero Electricity Connections** the utility limits the total PV energy outflow to be less than or equal to the total grid energy inflow over a 365-day period, hence the name Net-Zero Electricity Connection.

- In these jurisdictions, Net-Zero Ready and Net-Zero Energy homes are only possible when only electrical energy is used. NZr, or NZ homes will require the use of all-electric mechanical systems.

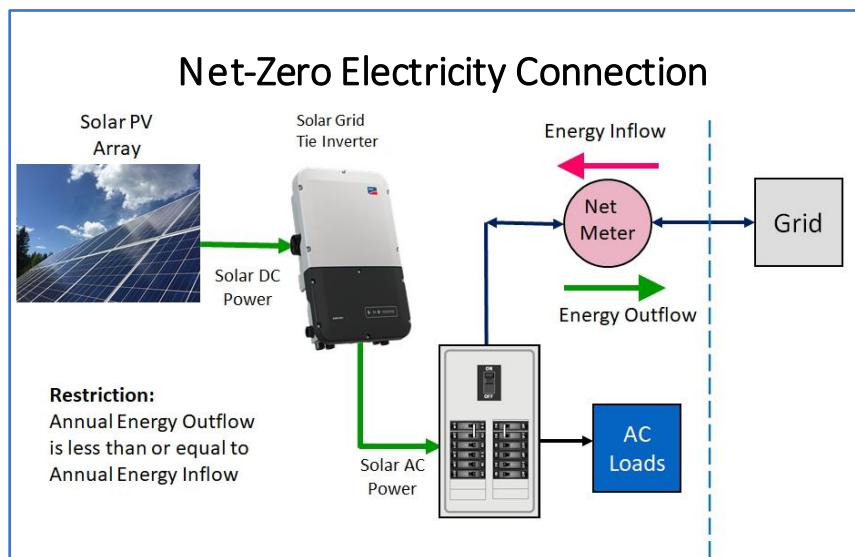

Figure 9: Electrical Configuration for Net-Zero Electricity Connections - courtesy of Riverside Energy Systems with Inverter image courtesy of SMA

## Option 2D: Self-Use Grid Connection

“Self-use grid connections” require that all solar PV generated electricity be used on site. This type of utility connection does not permit energy outflow to the grid at any time.

- Requires on-site battery to store surplus solar PV energy during periods of over production, for later use by on-site loads.
- Requires a self-use controller to regulate solar PV power output for zero outflow to the grid when the battery is fully charged and surplus solar PV power is available.
- Requires solar PV inverters that can generate AC in parallel with the grid using solar PV and/or stored battery energy.

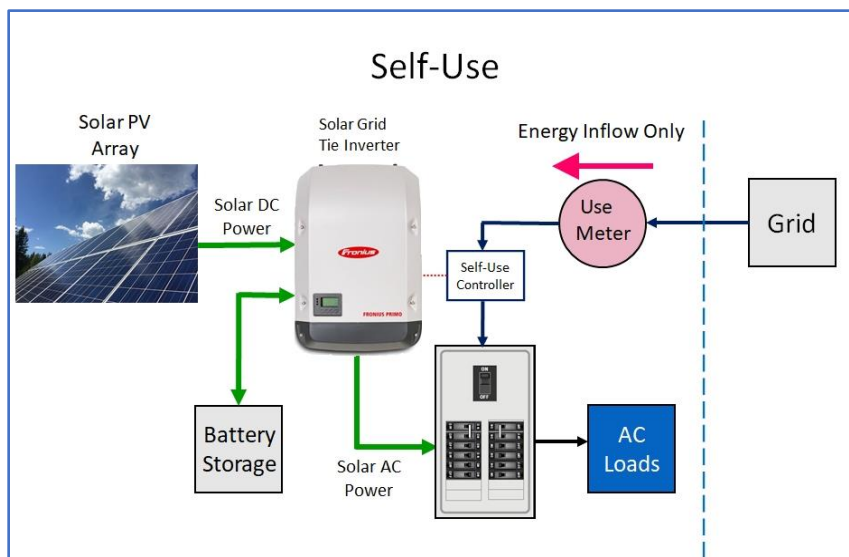

Figure 10: Electrical Configuration for Self-Use - courtesy of Riverside Energy Systems with Inverter image courtesy of Fronius

## Option 2E: No Grid Connection / Off-Grid Solar PV System

“Off-Grid Solar PV systems” are stand-alone electrical systems without a grid connection.

- Requires on-site battery to store surplus solar PV energy during periods of over production, for later use by on-site loads.
- Off-grid systems normally incorporate a backup generator to make up energy shortfalls in solar PV production.
- Requires a solar PV inverter-chargers that can both generate AC from the PV array and battery storage; as well as charge the battery via backup generator during times of insufficient solar PV production.

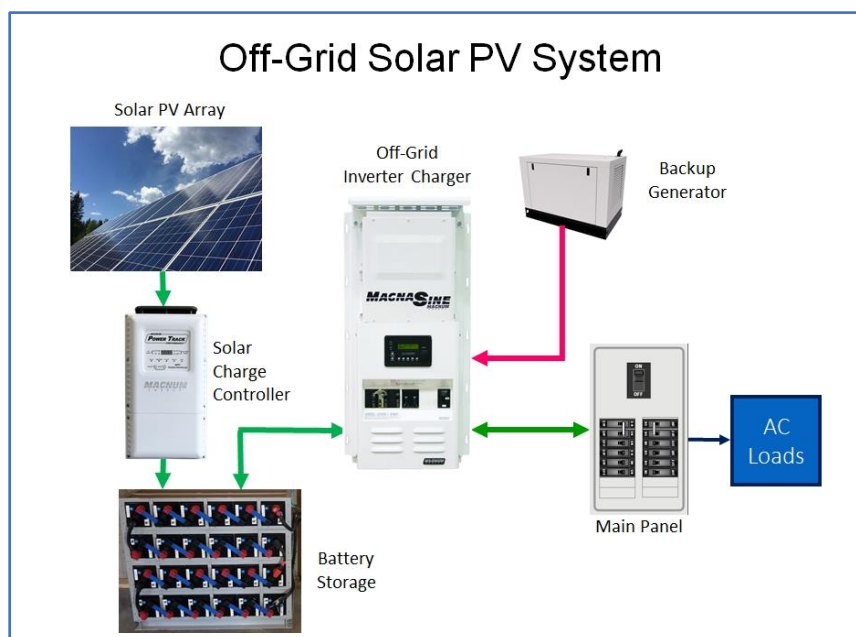

Figure 11: Electrical Configuration for an Off-Grid Solar PV System - courtesy of Riverside Energy Systems with product images courtesy of Magnum-Sensata

## Battery-Ready / Battery Storage Options

Including **Battery Storage** in a solar PV system:

- Increases overall solar installation costs;
- Is mandatory for off-grid systems;
- Requires allocation of space for a properly vented battery location and installation of charging equipment;
- Can store PV energy for later use in most grid connected systems (except FIT connections);
- Can store grid energy for later use under utility rate structures with Time-of-Use (TOU) billing, for additional savings;

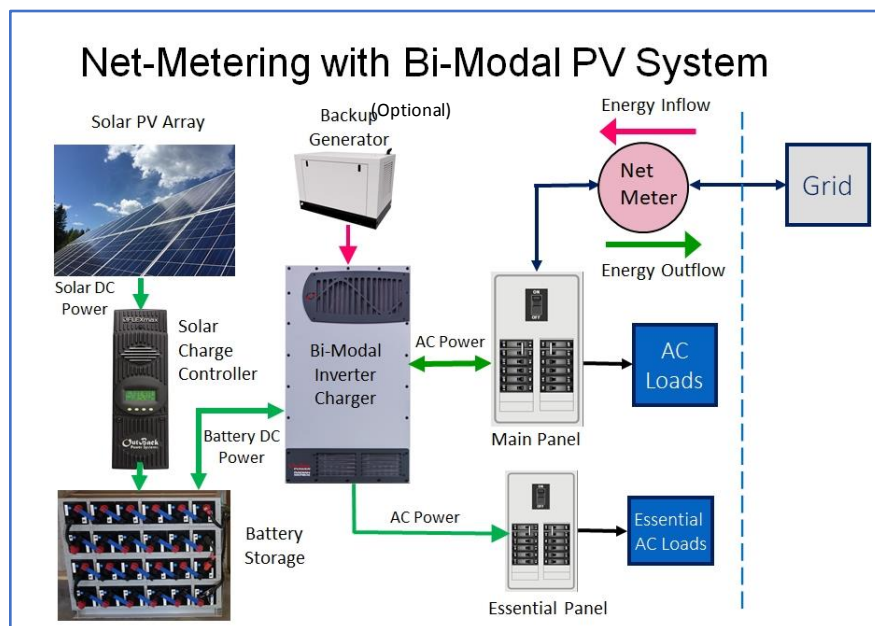

Figure 12: Net-Metering Solar PV system with Bi-Modal Inverter - courtesy of Riverside Energy Systems with equipment images courtesy of Outback Power Systems.

- Can provide back-up power during grid outages if a bi-modal inverter is used as shown in Figure 12.

### Battery-Ready Installations:

To accommodate the installation of battery storage in the future, the initial solar PV design and installation can be made “Battery Ready”. This will reduce the cost to the homeowner of installing battery storage at a later date.

Basic requirements for a Battery-Ready installations are:

- Provision of floor space for the battery storage installation, near the inverter location; and
- One of the following:
  - In Solar-Ready or Net-Zero Ready installations, ensuring the point-of-connection (e.g., main service panel or service splitter) has a bus rating that can accommodate the capacity of the future PV inverter/battery charger, corresponding to the planned solar PV array area (see STEP 6 for additional details), and enough wall space allocated for mounting the future inverter/charging equipment; or,
  - In Solar-Equipped or Net-Zero Energy installations, it is important to select an inverter that will integrate with the future installation of a bi-modal inverter and battery storage, and to allocate space to accommodate this equipment installation at a later date.

## STEP 3: Confirming Solar PV Integration Design Requirements

The initial two decision steps have defined:

- Builder’s preference for solar PV integration (covered in STEP 1);
- Electrical utility connection requirements for grid-connected PV systems (covered in STEP 2).

With these two pieces of information, it is now possible to define the design requirements for:

- Building envelope characteristics
- HVAC mechanical system characteristics
- Level of PV Integration in the build
- PV inverter characteristics
- Level of battery integration in the build

In STEP 3, the Builder and Integrated Design Team will:

- With the aid of a “**Planning Matrix**”, define for review the basic and optional components needed to integrate solar PV technology at the build site.
- Confirm that the house-build and solar PV system requirements are consistent with the overall goals set by the builder for the project, before proceeding with the detailed design decisions in STEPS 4 through 10 of this Guide.

### Planning Matrix

To use the planning matrix, provided in Table 3, the integrated design team first plots the results of STEPS 1 and 2 on the matrix table as shown in Figure 13.

- STEP 1 decision (i.e., *Builder’s preferences for solar PV Integration*) determines the matrix ROW;
- STEP 2 decision (i.e., *Utility connection requirements*) determines the matrix COLUMN.

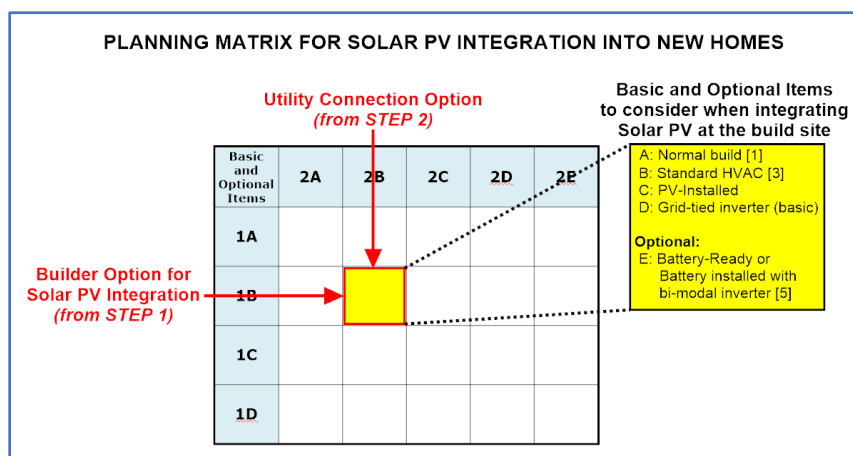

Figure 13: Planning Matrix of Basic and Optional Requirements for Solar PV integration at a Build Location

The intersection of the two will define the basic design requirements for solar PV integration at the build site, as well as any optional features that should be considered.

## STEP 3: Confirming Solar PV Integration Design Requirements

The five parameters and possible design options for each, are:

- A. Building Envelope:** Normal build / Enhanced build may be necessary
- B. HVAC mechanicals:** Standard HVAC / Enhanced efficiency HVAC / All-electric HVAC
- C. Solar PV Integration:** PV-Ready installation / Full PV installed
- D. Inverter:** No Inverter / Grid-tied inverter / Bi-modal inverter / Off-grid inverter-charger;  
(with or without self-use controller)
- E. Battery Integration:** No Battery / Battery-Ready / Battery installed

Table 3: Planning Matrix of Design Requirements for Solar PV Integration at a Build Location

Basic and Optional Design Requirements		Electrical Utility Grid Connection Option (from STEP 2)				
		2A: Feed-In-Tariff Connection	2B: Net-metering or Net-billing Connection	2C: Net-Zero Electric Connection	2D: Self Use Only Connection	2E: No Grid Connection Available [6]
Builder's Preferred Option for Solar PV Integration (from STEP 1)	1A: Solar-Ready Home	A: Normal build [1] B: Standard HVAC [3] C: PV-Ready D: No Inverter E: No Battery	A: Normal build [1] B: Standard HVAC [3] C: PV-Ready D: No Inverter <b>Optional:</b> E: Battery-Ready	A: Normal build [1] B: Standard HVAC [3] C: PV-Ready D: No Inverter <b>Optional:</b> E: Battery-Ready	A: Normal build [1] B: Standard HVAC [3] C: PV-Ready D: No Inverter E: Battery-Ready	A: Normal [1] or enhanced build [2] B: Standard [3], enhanced [2] or all-electric HVAC [4] C: PV-Ready D: Off-grid inverter-charger E: Battery-installed
	1B: Solar Equipped Home	A: Normal build [1] B: Standard HVAC [3] C: PV-Installed D: Grid-tied inverter E: No Battery	A: Normal build [1] B: Standard HVAC [3] C: PV-Installed D: Grid-tied inverter <b>Optional:</b> E: Battery-Ready or Battery installed with bi-modal inverter [5]	A: Normal build [1] B: Standard HVAC [3] C: PV-Installed D: Grid-tied inverter <b>Optional:</b> E: Battery-Ready or Battery installed with bi-modal inverter [5]	A: Normal build [1] B: Standard HVAC [3] C: PV-Installed D: Grid-tied inverter with self-use controller E: Battery installed <b>Optional:</b> E: Bi-modal inverter [5]	A: Normal [1] or enhanced build [2] B: Standard [3], enhanced [2] or all-electric HVAC [4] C: PV-Installed D: Off-grid inverter-charger E: Battery-installed
	1C: Net-Zero Ready Home	A: Enhanced build [2] B: Enhanced HVAC [2] C: PV-Ready D: No inverter E: No Battery	A: Enhanced build [2] B: Enhanced HVAC [2] C: PV-Ready D: No Inverter <b>Optional:</b> E: Battery-Ready	A: Enhanced build [2] B: All-electric HVAC [4] C: PV-Ready D: No Inverter <b>Optional:</b> E: Battery-Ready	A: Enhanced build [2] B: Enhanced HVAC [2] C: PV-Ready D: No Inverter E: Battery-Ready	A: Enhanced build [2] B: Enhanced HVAC [2] C: PV-Ready D: Off-grid inverter-charger E: Battery-installed
	1D: Net-Zero Energy Home	A: Enhanced build [2] B: Enhanced HVAC [2] C: PV-Installed D: Grid-tied inverter E: No Battery	A: Enhanced build [2] B: Enhanced HVAC [2] C: PV-Installed D: Grid-tied inverter (basic) <b>Optional:</b> E: Battery-Ready or Battery installed with bi-modal inverter [5]	A: Enhanced build [2] B: All-electric HVAC [4] C: PV-Installed D: Grid-tied inverter (basic) <b>Optional:</b> E: Battery-Ready or Battery installed with bi-modal inverter [5]	<b>DIFFICULT TO ACHIEVE</b>  Consider Option 1B: Solar-Equipped Home, with energy-efficiency upgrades [2] as an alternative	<b>DIFFICULT TO ACHIEVE</b>  Consider Option 1B: Solar-Equipped Home, with energy-efficiency upgrades [2] as an alternative
<b>Battery Requirements</b>	<b>Battery not required</b>	<b>Battery-Ready or Battery Installation optional</b>	<b>Battery-Ready or Battery Installation optional</b>	<b>Battery-Ready or Battery Installation required</b>	<b>Battery Installation required</b>	

### NOTES:

- Normal-builds use envelope design parameters that are normally used by the builder for houses in the region. These houses could use either "standard" or "enhanced" envelope designs, depending on what is normal for the builder.
- Net-Zero house designs require enhanced-builds with envelope upgrades to reduce the home's annual heat load by at least 33% compared to a reference house, and enhanced-efficiency HVAC mechanical systems in order to reduce the home's energy usage budget, which can then be balanced by energy collected by the planned or installed solar PV system.
- Standard HVAC mechanical may use fuel and/or electricity to provide energy needed by the home. If fuel is used, it commonly provides some or all of the space and domestic hot water heating requirements of the home.
- All-electric HVAC mechanicals use space and water heating technologies that are powered by electricity and do not consume fossil-fuel (e.g., passive solar and/or heat pump technology for space heating, and solar and/or heat-pump water heating for domestic hot water).
- In grid-connected systems with battery storage, use of bi-modal inverters can provide back-up electricity to essential loads during grid outages.
- All off-grid houses will require battery storage. Inverters-chargers must be capable of operating without grid supply.

## Scenarios Requiring All-Electric HVAC Mechanicals

There are two design scenarios where all-electric HVAC mechanicals should be used in order to achieve, or have the potential to achieve the renewable energy performance targets defined for these housing projects. These scenarios involve:

- Utility jurisdictions that limit the capacity of grid-connected PV systems based on an annual electrical energy use. (*i.e.*, *Option 2C: Net-Zero Electric Connection column in Table 3*),

Combined with either:

- Net-Zero Ready Homes (*i.e.*, *Option 1C*), or
- Net-Zero Energy Homes (*i.e.*, *Option 1D*).

With Option 1D, Net-Zero Energy Home case, the utility restriction of net-zero electric production from PV will not allow for an overproduction of PV electricity to balance the use of natural gas or other fossil fuels by the HVAC mechanical systems (excluding renewable biomass) in order to achieve the annual net-zero energy budget for the home. The only way net-zero (NZ) energy performance can be achieved is to use all-electric and /or renewable energy mechanicals in these jurisdictions.

With Option 1C, Net-Zero Ready Home case, it is possible to achieve the net-zero ready (NZr) designation, while using fossil-fuel based mechanicals, in jurisdictions with net-zero electric production restrictions, since the NZr designation is based on modelled energy budgets and provision of suitable areas for installing future PV arrays large enough to balance the annual energy budget to net-zero.

- However, NZr houses with fossil-fuel based mechanicals will not be able to be converted to net-zero energy homes by simply adding solar PV systems in the future, as the utility restriction on renewable energy production will limit the solar PV array capacity to offset only the on-site electricity usage, but not the on-site fossil-fuel usage.

The only way achieve the NZr designation in a house-design that can be converted to a net-zero energy home in the future is to use all-electric mechanicals in these jurisdictions.

## Scenarios Difficult to Achieve

There are two design scenarios that are difficult to achieve in the bottom-right corner of the planning matrix. These involve:

- Net-Zero Energy Homes (*i.e.*, *Option 1D*),

Combined with either:

- Utility grid connections that do not allow energy outflow from the Solar PV system to the grid (*i.e.*, *Option 2D: Self-Use Only Connection column in Table 3*), or
- Off-grid build locations with no grid connection possible (*i.e.*, *Option 2E: No Grid Connection Available column in Table 3*).

In these cases the integrated design team is advised to consider the solar integration approaches described in *Solar-Equipped Homes (i.e., Option 1B)*; together with energy-efficient enhancements to reduce the on-site energy budget for the home, which could include changes to:

1. *The building envelope and /or*
2. *The HVAC mechanical system.*

## Examples of Using the Planning Matrix

### Example 1:

Builder Preference for Solar Integration – **1B: Solar-Equipped Home** (from STEP 1)

Grid Connection as specified by local utility – **2B: Net-metering connection** (from STEP 2)

### PLANNING MATRIX Output:

#### Basic Requirements:

- A. Normal build [1]
- B. Standard HVAC [3]
- C. PV-Installed
- D. Grid-tied inverter
- E. Battery-Ready or Battery installed with bi-modal inverter [5]

#### Optional Items:

#### Review Summary: (as an example)

- Review of the basic design requirements are consistent with the builder’s expectations.
- Builder reviewed optional items and has decided not to include any storage option in the project.
- Builder approval given to proceed with remainder of the solar PV Integration decisions by the Integrated Design Team.

### Example 2:

Builder Preference for Solar Integration – **1C: Net-Zero-Ready Home** (from STEP 1)

Grid Connection as specified by local utility – **2C: Net-Zero Electric connection** (from STEP 2)

### PLANNING MATRIX Output:

#### Basic Requirements:

- A. Enhanced build [2]
- B. All-electric HVAC [4]
- C. PV-Ready
- D. No Inverter

#### Optional Items:

- E. Battery-Ready

#### Review Summary: (as an example)

- Review of the basic design requirements are consistent with the builder’s expectations.
- Builder reviewed optional items and has decided to make the house “Battery-Ready” and design to accommodate a future bi-modal inverter for critical loads backup.
- Builder approval given to proceed with remainder of the solar PV Integration decisions by the Integrated Design Team.



### STEP 3: Confirming Solar PV Integration Design Requirements

---

- *Details of any enhancements to the building envelope are to be developed as part of the net-zero-energy design.*
- *HVAC will be planned around use of high performance, air-source heat pump technology to fulfill the “All-electric HVAC” requirement.*

#### Example 3:

Builder Preference for Solar Integration – **1D: Net-Zero-Energy Home** (from STEP 1)

Grid Connection as specified by local utility – **2D: Self-Use Only Connection** (from STEP 2)

#### PLANNING MATRIX Output:

**DIFFICULT TO ACHIEVE**; Consider “Option 1B: Solar-Equipped Home”, with energy-efficiency upgrades [2] as an alternative.

#### Review Summary: (as an example)

- The builder and design team agree that the Net-Zero Energy Design is not practical due to utility restrictions on electricity outflow to the grid.
- After reviewing options with the builder and homebuyer, solar integration will go ahead with:
  - *Solar PV installation with battery storage and the optional bi-modal inverter, and*
  - *Design team is to consider efficiency upgrades to the building envelope and HVAC mechanicals to reduce the need for grid electricity and back-up heating fuel.*

## STEP 4: Defining Annual PV Energy Production Target

With the builder's goal clearly in mind, the PV consultant can do a comprehensive solar study on the location and the effectiveness of the solar PV system(s). These assessments will be accurate provided the PV consultant has all the necessary information, including:

- Building plans
- Landscape plans
- Access to the build-site to enable solar assessment with solar photography
- Annual PV energy production target

Additional information on solar site assessments is provided in **Appendix A, Common Solar PV Questions and Clarifications for Builders** in the responses to Questions 3 and 4.

### Option 4A: No Annual PV Generation Target

In this case the builder has no specific PV energy generation goal, or they are simply roughing in for a future solar installation.

A PV consultant can:

- Determine the potential generation capacity of the roof space or alternate PV locations.
- Determine how well a solar PV system is likely to perform given possible array capacities, placements, and measured local shading constraints.
- Ensure the building plans, electrical infrastructure, and mechanical equipment placements (vents, stacks, etc.) adequately provide for solar PV installation.
- Highlight structural impacts for review by others to ensure solar PV can be accommodated.

### Option 4B: Partial Energy Offset Target

The builder may have a specific solar PV energy production target. The PV consultant's assessment, solar modelling, and guidance will determine whether or not the target can be met without design changes. The PV consultant will identify any issues standing in the way of solar production targets and suggest possible solutions to increase solar performance at the build site.

### Option 4C Net Zero Energy Usage

If a builder is looking to certify NZ or NZr they will have to contract an EA to determine the building's annual energy consumption.

The Energy Advisor:

- Uses the building plans provided to create an energy model for the building.
- Estimates the annual energy use of the building based on standard operating conditions.
- Provides feedback and energy conservation recommendations to reduce energy use of the building.

## Step 4: Defining Annual PV Energy Production Target

The annual energy use may be expressed as either Giga-Joules (GJ) and/or kilo-watt-hours (kWh).

1 GJ = 277.8 kWh  
1 kWh = 0.0036 GJ

Once the EA has determined the annual energy use for the building to meet NZ or NZr, the builder passes along that information to the PV consultant who will size and design solar PV systems based on builder's PV energy production targets.

## Solar PV System Utility Compliance

Electrical utilities have differing approaches for solar PV related:

- Generation interconnection guidelines
- Revenue metering
- Rate structures
- Grid connection methods
- Capacity limits

Grid-connected solar PV designs must:

- Adhere to utility requirements and limitations;
- Have approval secured from the utility before a solar PV system installation begins.

The solar PV consultant is familiar with these requirements and can provide jurisdiction specific guidance for the solar PV integration project.

### NOTES:

1. The kilo-watt-hour (kWh) is the unit of electrical energy on which utilities bill their customers. Electrical power (kW), is the **rate electrical energy (kWh) is being produced or used** at a moment in time.
2. PV System Output Power (kW) x Hours at that Output = PV Energy Produced (kWh)
3. Peak power output rating of a solar PV system (kWp), is specified for standardized (STC) conditions under which all solar modules are factory tested. Actual PV system power output (kW) is not constant but rather varies continuously depending on time of day, weather patterns, temperature, shading, month of the year, system losses etc.
4. While PV system output power (kW) at any particular time is very difficult to predict, monthly and annual energy production (kWh) can be predicted.

### EXAMPLES:

1. A 10 kWp solar PV system generating at 5 kW constantly for 30 minutes will produce 2.5 kWh.
2. A 20 kWp solar PV system generating at 18 kW constantly for 6 minutes will produce 1.8 kWh.

## Battery Storage Requirements

If the system design includes battery storage, the PV Consultant and / or the EA can provide guidance to builder on the capacity of battery storage to be considered along with the space requirements that need to be allocated for installation now, or in the future in the case of a "Battery-Ready" option.

## STEP 5: Defining Solar PV Array Location(s) and Size(s)

The solar consultant will consider available solar array locations to determine viable solar capacities, predicted solar energy generation, and minimum required array sizes to achieve the solar production targets identified in STEP 4.

Solar panels produce energy primarily from sun light striking perpendicular to the array surface. In Canada, south-oriented solar PV panels placed at an angle matching the homes longitude typically provides optimal annual energy production, but alternate orientations can be highly effective as well.

Each region may have specific regulations regarding solar panel location. Some regions require that structures have a primary function aside from simply supporting solar PV systems.

### Solar array locations can include:

- Option 5A: House-roof mounted arrays
- Option 5B: Adjacent structure mounted arrays
- Option 5C: Mounting on walls or railings
- Option 5D: Ground mounted arrays

### Option 5A: House-roof mounted arrays

House-roof mounted arrays, as shown in Figure 14, are commonly used when integrating solar PV into a home. Larger continuous solar array sections reduce costs compared to multiple smaller sections. Roof sections interrupted by hips, valleys, gables, and dormers can lead to a more expensive solar installation and undesirable self-shading.

An integrated design approach will facilitate roof design options that simplify solar PV design, lower installation costs, and improve expected solar PV energy generation.



Figure 14: Roof Mounted PV System using South and West Facing Arrays  
- courtesy Riverside Energy Systems

### Option 5B: Adjacent Structure mounted arrays

The roofs of adjacent structures to the house can provide suitable surfaces for mounting solar PV arrays. These can include:

- Outdoor picnic, cooking or leisure shelters; (see example in Figure 15).
- Detached garages, car-ports or parking shelters; (see example in Figure 16).



Figure 15: Outdoor Leisure Area Solar PV shelter  
– courtesy Lumos Solar

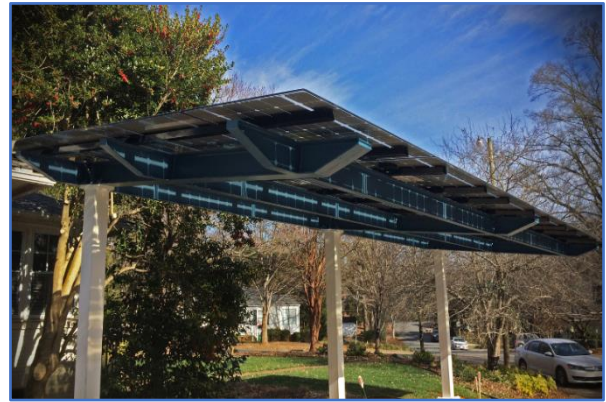

Figure 16: Residential Solar PV Parking Shelter  
– courtesy Lumos Solar

### Option 5C: Mounting on walls or railings

South-facing walls or railings can provide suitable surfaces for solar mounting provided they are not shaded by surrounding obstacles. Wall mounted arrays are often located high on building walls to reduce the potential for damage and shading, especially in winter months.

- If the array racking is tilted off the wall as shown in Figure 17, the solar PV array can function as an awning to shade windows and doors located below the array. This mounting arrangement will:
  - Increase overall solar energy production compared to a vertical installation;
  - Reducing summer air-conditioning loads in the home due to the shading provided.



Figure 17: Residential Wall-mounted Solar PV system  
- courtesy of Blue Water Energy

### Option 5D: Ground mounted arrays

Ground mounted arrays, such as the one shown in Figure 18, are structures located adjacent to the home; whose sole purpose is to support the solar PV array. Advantages of this type of mounting include:

- Array can be positioned to face due south.
- Array angle can be set to optimize electricity production at the build site.
- Seasonally adjustable racking is available to maximize annual solar production, if required.

Before considering a ground-mounted array, it is recommended to check local regulations governing their acceptability and design requirements.



Figure 18: Ground-mounted Solar PV Array  
- courtesy of Riverside Energy Systems

## Solar Access and Site Shading Considerations

Solar module output power depends on the levels of direct sunlight striking perpendicular to its cells. Shade drastically reduces solar module power output at any moment in time and over the course of a year, lowers its annual energy production.

Best solar PV system performance requires that shading be carefully considered early in the design process, avoided by all possible means, and mitigated by solar PV equipment choices.

Solar PV designers must assess and account for two forms of array shading:

### External Shading

- Caused by obstacles external to the building such as: trees, adjacent buildings, mountains, signs, power lines and snow.
- Can limit solar PV feasibility.
- Can be difficult to address directly.
- Can be accurately measured and assessed with site solar photography.
- Can be accounted for in solar modelling and energy production projections.
- Might be mitigated by changing the location and/or orientation of the solar panels, and the choice of inverter technology.

### Self-Induced Shading

- Caused by features of the building:
  - *Dormers and gables (see Figure 19);*
  - *Plumbing Stacks;*
  - *Roof Vents;*
  - *Satellite dishes.*
- Can be assessed with 3D modeling.
- Can often be eliminated through careful integrated design decisions and collaboration during construction.
- Can be mitigated through choice of inverter technology.

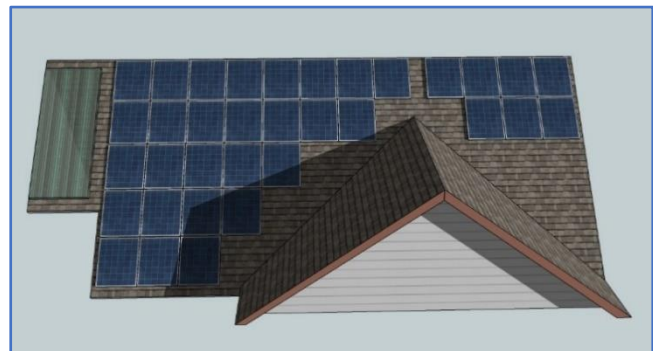

Figure 19: Example of Self-Induced Array Shading by Roof Gable  
- courtesy of Riverside Energy Systems

## STEP 6: Electrical Impacts and Point-of-Connection Methods

Solar PV systems can significantly affect required electrical infrastructure for the home. These must be identified during integrated design and implemented during construction through collaboration between solar PV consultant, electrician, and solar PV installer to avoid limiting the capacity and /or incurring extra costs to accommodate the installation of the solar PV system.

### Electrical solar PV impacts and considerations include:

- Service configuration and equipment sizing can limit the allowable solar PV capacity size as described in Section 64 of the Canadian Electrical Code (CEC).
- A dedicated solar PV generation lockable AC disconnection means is required by CEC and utilities and may need to be specifically located to meet local utility requirements.
- Other local utility connection requirements or limitations when using a grid connected approach need to be considered (e.g., requirement for installation of a self-use controller, annual limits on electrical energy outflows or exports to the grid).
- Solar PV electrical cables, conduits, or raceways are required between specific parts of the building based on the PV system design, solar equipment locations, and the point-of-connection to the utility, and whether or not battery storage is included in the PV system design.
- If a bi-modal inverter is used to provide back-up power during grid outages, house branch circuits may have to be segregated and wired to separately supply critical and non-critical loads.

Guidance from a solar PV professional well versed in CEC renewable energy systems requirements before site electrical work begins is key to ensuring desired solar PV capacity can be safely accommodated. CEC requires that solar PV DC wiring inside the building be enclosed in metal.

- Armored cables meet this requirement.
- Metallic electrical conduits or raceways meet this requirement.
- Using PVC electrical conduit constrains the inverter placement to outside the building.

### NRCan's Photovoltaic Ready Guidelines

The PV Ready guide provides the following guidance for solar PV electrical conduit installation:

- Will terminate at least 6" above the desired insulation level and no less than 18" from the underside of the roof sheathing.
- Have as few bends as possible; straight up and down is ideal.
- Will include a pull rope for later conductor or cable installation.
- Will be capped to preserve envelope air tightness until the solar system is installed.

PV system electrical conduit inside a building, must be metallic if it will house DC carrying conductors. Exact solar PV conduits sizes, start and end locations, and paths will be specified by the solar PV consultant in consultation with the builder and the electrician performing solar PV rough-in.

### Point-of-Connection Options

Three point-of-connection options for solar PV systems are describe in the following sections.

## Option 6A: Feed-in-Tariff (FIT) circuit breaker/disconnect

This point-of-connection option is used when the utility connection requirements are based on

### Option 2A: Feed-in-Tariff (FIT) connection.

With **Option 6A**, the solar PV system is connected via dedicated FIT circuit breaker (or fused-switch disconnect) and a separate FIT meter to the utility grid as shown in Figure 20.

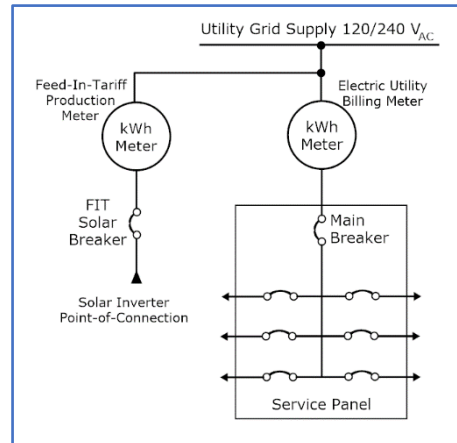

Figure 20: Feed-in-Tariff Point-of-Connection

## Option 6B: Main service-panel circuit breaker/disconnect

This point-of-connection option is used for **all utility connections other than Option 2A**, when the **capacity of the solar PV system is small enough to be accommodated by the main service panel**.

With **Option 6B**, the solar PV system is connected to the grid via a dedicated 2-pole single phase breaker located in the main electrical service panel of the house as shown in Figure 21.

The maximum allowable solar PV system breaker (or fuse) rating and hence the maximum solar PV system size that can be connected using Option 6B, is specified by CEC Rule 64-114, point-of-connection bus capacity requirement:

$$\text{Solar PV AC Breaker Rating} + \text{Main AC Breaker Rating} \leq 125\% \text{ of Bus Rating}$$

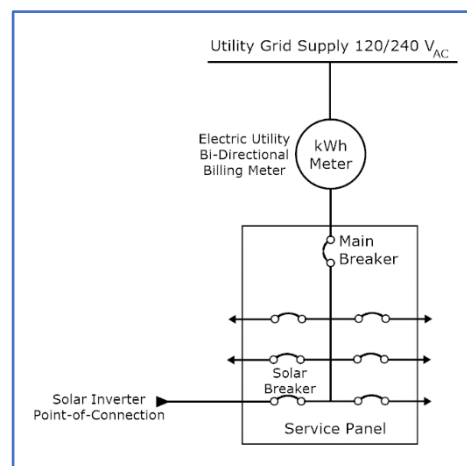

Figure 21: Main service panel Point-of-Connection

### Electrical service panel selection when using Option 6B:

- Electrical service panels in new homes will have main breakers for grid supply with ratings of 100 Amp, 125 Amp, 200 Amp or 400 Amp for grid supply based on the home design and capacity provided by the utility.
- Main service panels may have bus current ratings (bus capacity) exceeding the main supply breaker rating depending on make and model of panel;
- Careful selection of main service panel (i.e., make and model) with higher bus ratings will allow for connection of larger solar PV systems using Option 6B, while minimizing point-of-use connection costs.
- In Solar-Ready installations, the choice of main service panel with too low a bus rating may limit future solar system capacity, as illustrated in Figure 22.



**Examples of maximum solar PV capacity with two different makes/models of 200-Amp residential service panels with different bus ratings:**

1. Main breaker = 200 Amp; Main Panel Bus Rating = 200 A; Maximum Solar PV Breaker = 50 Amp  
Maximum Inverter Capacity = 50 Amp x 80%\* x 240 Volts = 9,600 W or 9.6 kW
2. Main breaker = 200 Amp; Main Panel Bus Rating = 225 A; Maximum Solar PV Breaker = 80 Amp  
Maximum Inverter Capacity = 80 Amp x 80%\* x 240 Volts = 15,360 W or 15.4 kW



Figure 22: Intended 15 kWp System Limited to 10 kWp by Electric Service Panel Choice  
- courtesy of Riverside Energy Systems

## Option 6C: Service Splitter with solar circuit breaker/disconnect

This point-of-connection option is used for **all utility connections other than Option 2A**, when the rated capacity of the solar PV system is too large to be accommodated by the main service panel.

With **Option 6C**, the solar PV system is connected via a separate solar-system circuit breaker (or fused-switch disconnect) to a service splitter as shown in Figure 23.

In this arrangement, it is the splitter rating or the utility conductor ampacity rating, whichever is lowest, that determines the maximum Inverter capacity.

**For example, 200-Amp utility conductors supply a 400-Amp splitter connected to a 200-Amp main panel. The maximum solar PV capacity is:**

Maximum Solar PV Breaker = 200 Amp

Maximum Inverter Capacity = 200 Amp x 80%\* x 240 Volts = 38,400 W or 38.4 kW

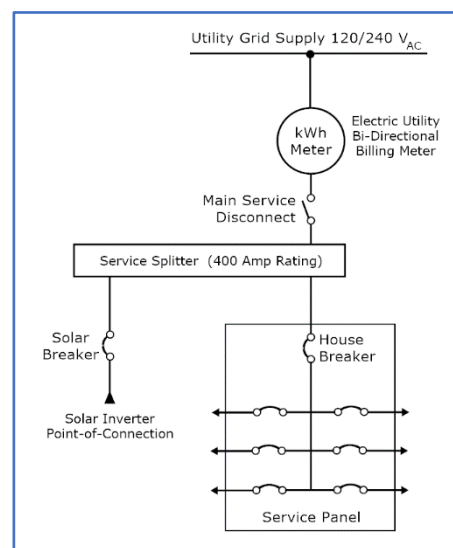

Figure 23: Service Splitter used as Point-of-Connection

\* **Note:** For reliable operation, breakers/fuses must not be continuously loaded to more than 80% of their rated capacity.

## STEP 7: Structural Impacts and PV System Attachment Methods

### Structural Impacts

Solar PV arrays impact the structures on which they are mounted.

- Rather than adding uniform dead load, arrays can produce significant point loading particularly when snow covered.
- In similar fashion, array uplift forces are concentrated at anchoring points. Anchoring components and attachment hardware must be designed to resist these forces without damaging the roof decking and / or roof covering.
- Attachment methods that penetrate the roof covering provide potential points for moisture ingress which could impact structural integrity of the roof decking, roof substructure and /or the mounting hardware used for attachment.
- Ballasted attachment methods increase roof dead load significantly, can potentially interfere with roof drainage, and can cause abrasion of the roofing membrane if not properly installed.

#### **NOTE to Builders, PV Consultants and Installers Concerning Racking Attachment Methods:**

Solar PV mounting approaches must be reviewed and finalized through integrated design discussions between the builder, PV consultant, structural engineer and the authority having jurisdiction (AHJ) for the installation.

Builders are to consult with their structural engineer (via truss manufacturer and/or independently) for professional structural assurances before selecting any attachment method, and all attachment components and hardware fasteners used in the installation of the solar PV system.

The CSA publication, *“Solar photovoltaic rooftop-installation best practices guideline”*, SPE-900 [3], provides additional details on installation requirements.

Racking attachment strategies should:

- Simplify installation;
- Minimize structural and roof-covering impacts;
- Be flashed, sealed and water tight;
- Resist corrosion and maintain structural integrity throughout the lifetime of the installation.

Solar PV panels can be fastened to residential rooftops in various ways. Common methods are:

- Option 7A: Flashed anchors secured into roof sub-structure (e.g., roof trusses)
- Option 7B: Flashed anchors secured into roof decking
- Option 7C: Standing seam metal roof clamps
- Option 7D: Ballasted systems used on flat roofs

## Option 7A: Flashed anchors secured into roof sub-structure

The most common solar racking attachment methods for residential projects involve anchoring to the roof substructure (e.g., roof trusses).

Four techniques for doing this are:

- i. Using J-bolts or U-bolts that hook under or around truss top chords. These may be appropriate where anchor spacing requirements align with truss spacing.
- ii. Using structural blocking secured between trusses using approved fasteners (concept shown in Figure 24). This allows lag bolting of anchors without fear of truss damage. An accurate blocking plan prepared in advance for the framing crew will simplify later solar PV installation.
- iii. Lag bolting of anchors into scab members that have been attached to roof-truss top chords following the procedures described in TPIC technical bulletin #7 [4].
- iv. Direct lag bolting of anchors into roof-truss top chords is also used by some PV installers\*.



Figure 24: Lag Bolted Anchors to Blocking between Trusses:  
- Sub-structure (top); Flashed Anchors with Racking (bottom)  
- courtesy Riverside Energy Systems

**\* NOTE to Builders, PV Consultants and Installers from the Truss Plate Institute of Canada (TPIC) [4]**  
TPIC Solar Ready (SR) trusses are not designed to accommodate lagging directly into truss top chords. This method of attachment is not recommended by the TPIC.

## Option 7B: Flashed anchors secured into roof decking

Solar PV anchor/flashing products engineered and approved to fasten with screws directly into eligible roof sheeting or decking installations are also commercially available as shown in Figure 25.

This type of anchoring system is use more in solar PV retrofit installations but may also be considered for new builds.



Figure 25: Flashed Anchors screwed to Roof Decking, with racking attached - courtesy Riverside Energy Systems

## Option 7C: Standing seam metal roof clamps

In the case of standing seam metal roofs, it may be possible to attach solar PV racking directly to the roofing using standing-seam clamps that are designed to be compatible with the roofing system as illustrated in Figure 26.

This method has the advantage of reducing or eliminating roof membrane penetrations associated with other solar array anchoring methods.

By reviewing this option during the integrated design process, standing seam roofing products of sufficiently heavy gauge and suitable seam spacing can be identified and considered in advance of the installation.



Figure 26: Racking Attachment to Standing Seam Metal Roofing - courtesy Riverside Energy Systems

## Option 7D: Ballasted systems on flat roofs

Ballasted racking may be appropriate for flat roof applications (i.e., less than 7-degrees of slope), as shown in Figure 27.

An engineered placement of ballasted blocks secures solar PV arrays to withstand site wind and seismic loads using few, if any mechanical attachments to the roof assembly.

Ballasted racking adds additional roof dead loading and possible snow-drift loading, which require review and professional structural assurances during the integrated design process.



Figure 27: Example of a Flat Roof Ballasted Solar PV Array - courtesy Riverside Energy Systems

### References

3. "Solar photovoltaic rooftop-installation best practices guideline", CSA Publication CSA SPE-900, September 26, 2013.
4. "Solar Ready Truss Design Procedure", TPIC Technical Bulletin #7, Revised March 12, 2020. PDF copy available at: [https://tpic.ca/wp-content/uploads/2018/05/technical\\_bulletin\\_no7\\_20120312.pdf](https://tpic.ca/wp-content/uploads/2018/05/technical_bulletin_no7_20120312.pdf)

## STEP 8: Preferred Solar Module Technology

Residential solar installations most commonly use modules assembled using either poly-crystalline or mono-crystalline silicon cells.

The choice of solar module technology is influenced by:

- Desired aesthetics;
- Required PV array capacity;
- Use of unique building features;
- Mounting methods;
- Budget.

Depending on the particular requirements of at the build site, the solar PV consultant will recommend a solar module technology with the best overall fit for the project.

Several solar module options are available which are described in the following sections.

### Option 8A: Polycrystalline-Cell Modules

Poly-crystalline (poly) silicon cells are cell-wafers that are cut from multi-crystal ingots formed from molten silicon, resulting in cells with characteristic square-corners.

Once assembled into a typical multi-cell module with a white back-sheet and aluminum frames, the poly-cell modules have distinctive blue cells with white borders as shown in Figure 28.

Poly-cell modules are generally less expensive than mono-cell modules, though have somewhat lower efficiency.



Figure 28: Example of a Polycrystalline-cell module  
- courtesy of Riverside Energy Systems

### Option 8B: Monocrystalline-Cell Modules (Basic)

Mono-crystalline (mono) cell wafers are cut from single crystal silicon ingots, and have an octagonal appearance due to their beveled corners. Once assembled into typical multi-cell configurations with a white back-sheets and aluminum frames, the mono-cell modules have a distinctive “white diamond on black” appearance as shown in Figure 29.

Mono-cell modules are somewhat more efficient than poly-cell modules, and perform better under low light conditions.



Figure 29: Example of a Monocrystalline-cell module  
- courtesy of Riverside Energy Systems

## Option 8C: Monocrystalline-Cell, All-Black Modules

These mono-crystalline modules use black back-sheets, and black frames, giving an “All-black” appearance.

All-Black modules trade-off a slight reduction in efficiency at higher temperature for “improved” street-view aesthetics as shown in Figure 30.



Figure 30: 3.5 kWp Array using Monocrystalline-Cell, All-Black Modules  
- courtesy Riverside Energy Systems

## Option 8D: Monocrystalline-Cell, Bi-facial Modules

Bi-facial, mono-crystalline modules are manufactured with a clear glass back-sheet and a second layer of solar cells. The resulting translucent module is able to harvest electricity from light incident to both front and rear surfaces as shown in Figure 31, with potentially unique aesthetic appeal.

### Applications of Bi-facial Modules:

Bi-facial solar modules are often used on outdoor shelters, such as pergolas, or building features such as railings as shown in Figures 15, 16, and 32.

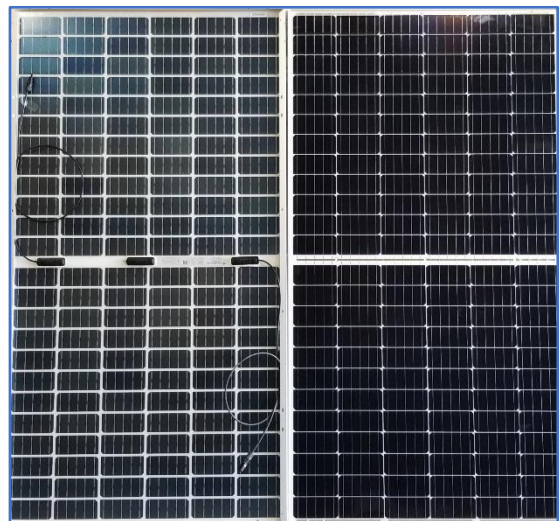

Figure 31: Two Bi-facial Solar Modules- back surface shown on left, front surface shown on right  
- courtesy of Riverside Energy Systems



Figure 32: Solar Railing using Bi-Facial Modules  
- courtesy of Riverside Energy Systems

## Other Solar Cell Technologies

Other solar cell technologies such as solar shingles, are examples of integrating photovoltaic cells into conventional roofing materials, and are described **Building Integrated Photovoltaics or BIPV products**.

- While BIPV roofing products are a promising technology, there is limited available to the Canadian marketplace.
- BIPV roofing and other unique PV technologies should be carefully reviewed with a solar PV consultant if being considered for a housing project in Canada.

## STEP 9: Preferred Solar Inverter Technology

Solar Inverters convert DC electricity from PV panels into AC electricity for use in the building and/or export to the grid.

Solar inverters perform several key functions including:

- Converting PV array DC electricity to 120/240V AC for grid connection and use in the home.
- Maximum Power Point Tracking (MPPT); an electronic method of extracting as much power as possible moment by moment from PV arrays, or individual PV modules under variations in incident light intensity throughout the day.
- Providing system data for performance monitoring of arrays, strings of modules, individual modules and inverters.

Depending on array locations, roof orientations and site shading constraints, a solar PV consultant will analyze and recommend appropriate inverter technologies for best solar PV performance.

- Residential grid-connected solar PV systems most frequently use string inverters, optimized-string inverters, or micro-inverters.
- In installations with battery storage, the use of bi-modal inverters will allow the generation of back-up power for the home during utility-grid power outages.

These different solar inverter options are described in the following sections.

### Option 9A: String Inverter

String inverters have 1 to 3 (typical) separate MPPT channels into which one or more series string(s) of PV modules (typically 8 – 12 modules of identical type) are connected as shown in Figure 33.

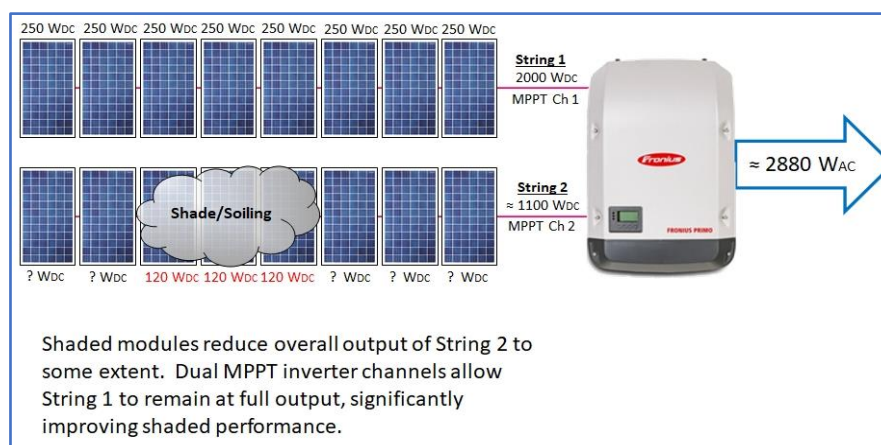

Figure 33: String Inverter with Dual MPPT Channels - Shaded Operation - courtesy of Riverside Energy Systems with inverter image courtesy of Fronius Canada

Module string length on each MPPT input need not be the same provided inverter input voltage limits are respected. The inverter separately optimizes available solar array DC power on each MPPT channel in real time.



When modules on any MPPT channel are shaded, available power is reduced only for that channel (e.g., String 2 in Figure 32); while remaining MPPT channels continue at maximum available power levels. Note that shaded modules draw down the output of their entire string to some extent; even though the other modules in the string are shade free.

String inverters work best when:

- Differing shade conditions between modules on the same MPPT channel rarely occurs.
- All modules on the same MPPT channel are in identical orientation (azimuth and tilt).
- Individual module-level performance monitoring is not required.
- Module-level Rapid Shutdown is not required.

### Option 9B: Optimized String Inverter

Optimized string inverters typically perform only the DC to AC conversion; using module level electronics to de-centralize the MPPT function to individual modules or module pairs. There are variations among manufacturers but Figure 34 illustrates a popular architecture.

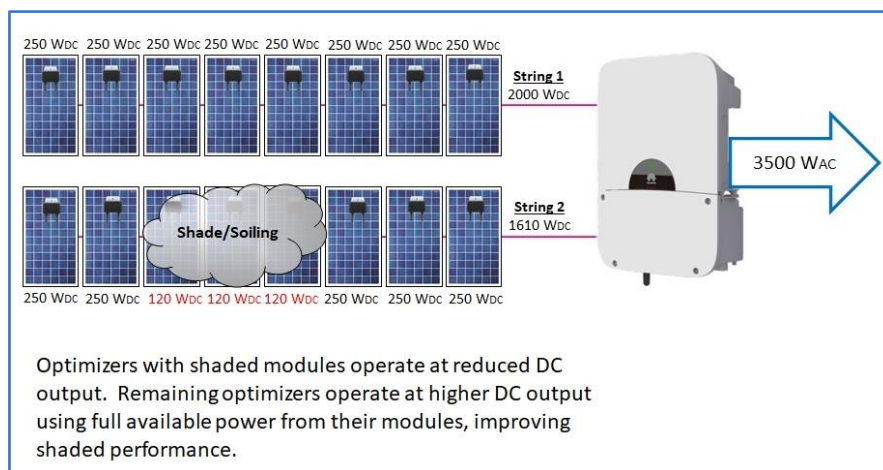

Figure 34: Optimized String Inverter - Shaded Operation - courtesy of Riverside Energy Systems with product image courtesy of Huawei

Optimizers mate with a solar module (or module pair) and mounted beneath them. MPPT is performed by each optimizer to extract maximum DC power in from its module (or module pair).

During partial shading, unshaded modules continue to operate at maximum power even when other modules in the same string are shaded. Optimizers and inverter communicate to maintain a constant DC string voltage for DC to AC conversion, and to provide performance data for individual module monitoring. Optimizers also provide module level rapid shutdown.

Optimized string inverters are best used when:

- Shade-tolerant design is important.
- Multiple PV array orientations will be used (e.g., differently oriented roof sections).
- Multiple module technologies will be used.
- Module level Rapid Shutdown is required.
- Using different string lengths is advantageous.
- Individual module monitoring is desirable.

## Option 9C: Micro Inverter

Micro-inverters use module-level electronics to de-centralize both DC to AC conversion and MPPT. Micro-inverters are mated with individual PV modules or module pairs and mounted below them as shown in Figure 35. Micro-inverter AC outputs are interconnected into AC trunk circuits to bring solar PV power off the array directly as AC.

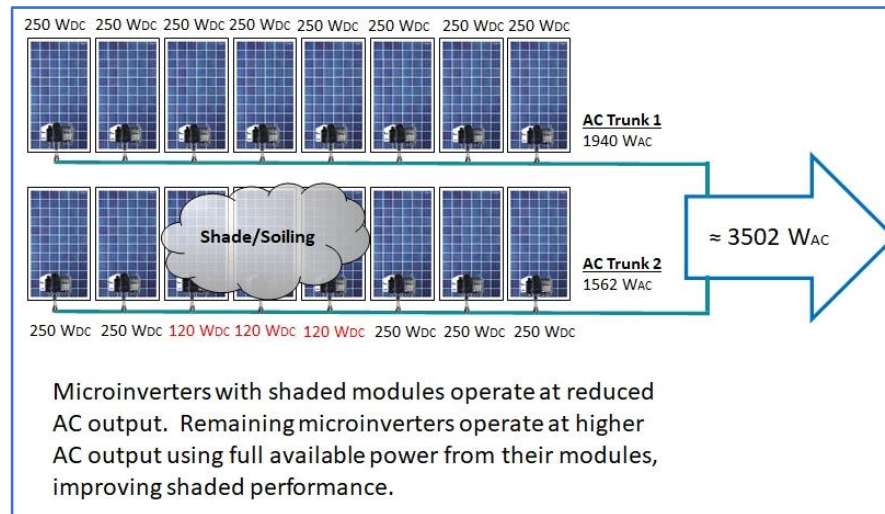

Figure 35: Microinverter – Shaded Operation - courtesy of Riverside Energy Systems with Microinverter Images Courtesy of Enphase

Unshaded modules/micro-inverters operate at maximum power even when others in the same AC trunk are shaded. Individual micro-inverters communicate performance data for monitoring. Micro-inverters also provide module level rapid shutdown.

Micro-inverters work best when:

- Shade-tolerant design is important.
- Modules or sub-arrays will be placed in more than one orientation (azimuth and tilt).
- Multiple module technologies will be used.
- Individual module monitoring is desirable.
- Module-level Rapid Shutdown is required.
- Bringing DC power into the building is undesirable.

## Option 9D: Bi-Modal Inverter

A bi-modal inverter can operate grid-connected, or stand-alone (off-grid) in the absence of grid supply; using solar PV and battery storage to provide backup power during grid outages.

As with other grid-connected inverters, surplus solar energy flows out to the grid during normal operation. Should the grid go down, a bi-modal inverter automatically disconnects from the utility, operates in stand-alone (off-grid) mode to supply essential AC loads; usually from a sub-panel designated for this purpose (see Figure 12 in STEP 2 as an example).

## STEP 10: Energy Monitoring Approach

An energy monitoring system is a valuable tool for providing feedback to homeowners to help them understand how their behaviour and operation of the home affects energy consumption.

In homes with solar PV installations, an energy monitoring system also provides valuable feedback on the performance of the PV system.

- For homes built to comply with Net Zero Home labelling program, there are mandatory monitoring requirements.
- For other homes, energy monitoring is optional.

Various energy monitoring approaches are described in the following sections.

### Option 10A: Monitoring Not Installed

With this option, no monitoring equipment is installed in the home.

- No real-time energy usage is available to the homeowner.
- Basic information on purchased energy consumption, on a whole-house basis, may be available from utility portals, after the fact.

### Option 10B: Basic Net-Zero Home Monitoring

This monitoring option provides basic compliance to the Net Zero Home labelling program. Basic monitoring systems typically include:

- In-house real-time display of electricity production and whole-house electricity consumption.
- Aggregate production and consumption information available over daily, weekly, and monthly time periods.

An example of a basic energy monitoring display screen is shown in Figure 36.

- The top of the screen shows the daily solar power generation (yellow line) and electricity consumption (blue line).
- The bottom of the screen shows daily values of solar energy production (yellow bars), and household energy consumption (blue bars) over a one-month period.

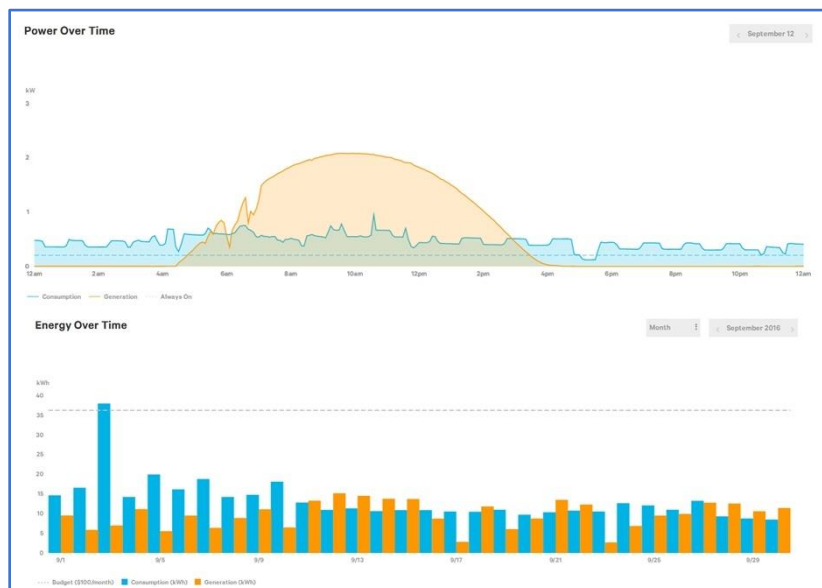

Figure 36: Example of a Basic In-house Energy Display  
- courtesy of Riverside Energy Systems

## Option 10C: Advanced Energy Monitoring of the Home

This monitoring option provides advanced energy monitoring that exceeds the basic requirements of the Net Zero Home labelling program. Advanced monitoring systems may include:

- Monitoring that normally supports display of information on a range of internet-enabled devices.
- Real-time display of electricity production, whole-house electricity consumption, and other parameters associated with the system.
- Aggregate production and consumption information available over daily, weekly, monthly and yearly time periods.
- May include monitoring of other utilities such as gas and water consumption.

An example of an advanced energy monitoring system is shown in Figure 37.

- The top screen displays daily production, consumption, export and import values on the left side, and on the right side, real-time solar power production by individual modules and the full array.
- The bottom screen displays monthly energy production, consumption, export and import on the left side, and monthly solar energy production by individual modules and the full array on the right side.

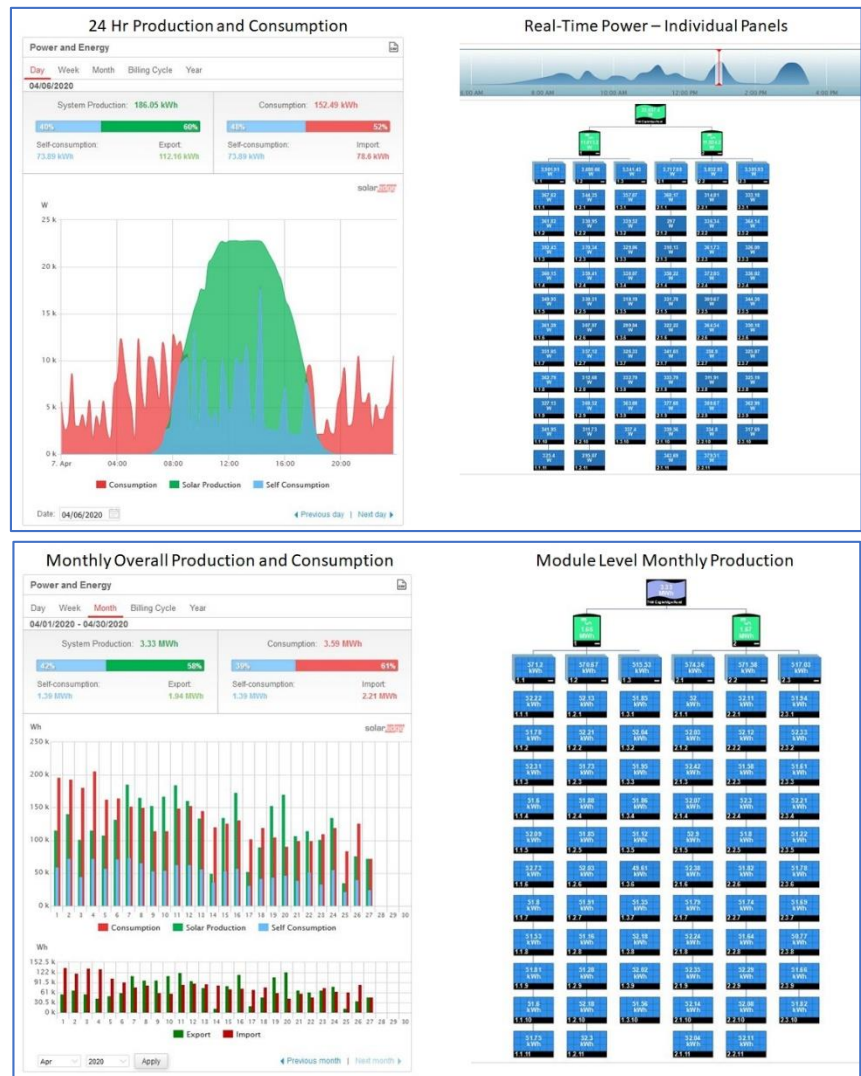

Figure 37: Example of an advanced energy display showing solar energy production and energy consumption for daily and monthly time periods - courtesy of Riverside Energy Systems

## APPENDIX A: Common Solar PV Questions and Clarifications for Builders

Solar PV is relatively new to the Canadian residential building market. As a result, important questions and need for clarifications arise amongst home builders and their clients that are worth exploring further. This section highlights some of the most common questions.

### 1. **Our integrated design team has developed a solar PV project strategy. As we transition to construction, how can we integrate this strategy into the build as seamlessly as possible?**

Solar PV build integration requires intentional, ongoing communication between design team, builder, trades teams, and other service providers; from the start of the design phase through to building occupancy. The construction team should have been represented during the integrated design, and all solar PV components and unique building requirements should be represented on the final plans.

To promote clear ongoing solar PV communication throughout the project, we highly advise these deliberate steps:

- a) Integrate solar PV placement, dimensions, specifications, and notes in all building drawings and written communication; including “preliminary”, “building/development permit”, and “issued for construction” versions. These should clearly identify:
  - *Unique solar PV structural impacts and requirements.*
  - *Unique authority having jurisdiction (AHJ) solar PV development guidelines*
  - *Approved solar racking attachment methods.*
  - *Electrical service solar PV requirements and cable routing considerations.*
  - *Solar PV roofing impacts and required flashing/sealing methods*
  - *Designated solar PV array locations, with notes prohibiting fresh air vents, plumbing stacks, chimneys, radon tubes, sky-lights, or other array obstructions in these areas.*
  - *Person(s) responsible for solar PV communications, permitting and approvals, with electrical utilities, safety authorities and other AHJs over the project.*
- b) During trades and services bidding and quotation, proponents should be provided a full drawing set, and advised to carefully consider how project solar PV requirements will affect the collaboration with others, products, services, and planning required of them.
- c) Once trades and services proponents have been selected, hold a compulsory Pre-Build Kick-Off meeting with those providers whose contribution are affected by and essential to the solar PV project strategy. We suggest at minimum including the builder, site construction manager, solar PV consultant and installer, electrical contractor, roofing contractor, plumbing/HVAC contractors, and truss supplier. The session should systematically review the solar PV strategy, the implications for and expectations of each stakeholder, confirm procedures and scheduling, and secure commitments for collaboration throughout the project for best solar PV outcomes.
- d) Construction review meetings during the build should include solar PV related checks, discussion and benchmarks.

## 2. Can you clarify the meaning of and differences between PV system power rating, power output, and energy production?

Solar module DC power ratings are based on measured instantaneous power output (Wp) under standard test conditions (STC) of direct solar irradiance 1000 W/m<sup>2</sup>, temperature 25 deg-C, with no cooling wind. STC is an established international standard for module factory testing and grading.

PV system owners often ask why their systems rarely if ever produce rated output power. PV system power output varies significantly throughout the day with changes in irradiance, array temperature, and wind speed; all of which are also subject to seasonal variations. Rated DC power output can only be expected at moments when PV site conditions closely replicate factory standard test conditions (STC). Below 25 deg-C and/or at irradiance above 1000 W/m<sup>2</sup>, solar module power outputs exceeding STC ratings are not uncommon, though usually short lived.

Figures 38 and 39 show 24-hour plots of AC power output for a 6 kWp system in Kamloops, BC on Aug 26 and Aug 23, 2019. Aug 26 was clear and sunny dawn to dusk, while Aug 23 was cloud covered to varying extents from 6:45 to 17:30. In both cases solar generation began shortly after sunrise and continued until sundown but with drastically different AC power(kW) outputs throughout the day.

Aug 26, power output had risen to 4400 W by 10:00, peaked at 5350 W at 13:00 (solar noon for daylight savings time), and fell to 4650 W by 15:00. This near ideal “bell shape” AC power curve is typical of clear days where direct solar irradiance striking the array varies only with the sun’s position in the sky. By contrast, Aug 23 under varying cloud compromise, power output was only 650 W by 10:00, peaked at 3700 W at 13:00, and fell to 1500 W by 15:00. On Aug 23, sunlight diffusion by variable cloud cover reduced the direct solar irradiance striking the solar array throughout the day, regardless of the sun’s position in the sky.

Figures 38 and 39 show solar PV output power varies throughout the day, and that the output reducing impacts of weather and cloud cover can be very significant. Even on clear sunny days peak PV system power output will likely fall short of maximum ratings due to effects including:

- Roof pitch limiting array direct solar irradiance even at solar noon.
- Module temperatures in excess of STC (25 deg-C).
- Array shading by obstacles other than clouds.
- Module mismatch, wiring, and other losses.

For the most part, residential electrical utility customers pay for energy use over time (kWh), and not for peak power demand (kW) at particular moments in time. Other than for performance diagnostics, solar PV system energy production over time (kWh per day, week, month, or year) is of much more interest than power output (kW) at any moment in time. Referring back to Figures 38 and 39, the area under each power plot is the energy production (kWh); 45.8 kWh and 17.6 kWh for Aug 26 and Aug 23, 2019 respectively.

Accumulated solar PV energy production (kWh) typical meteorological years (365 days) can be modelled by solar PV consultants during the integrated design process to establish confidence in meeting builder and home owner solar PV system performance goals.

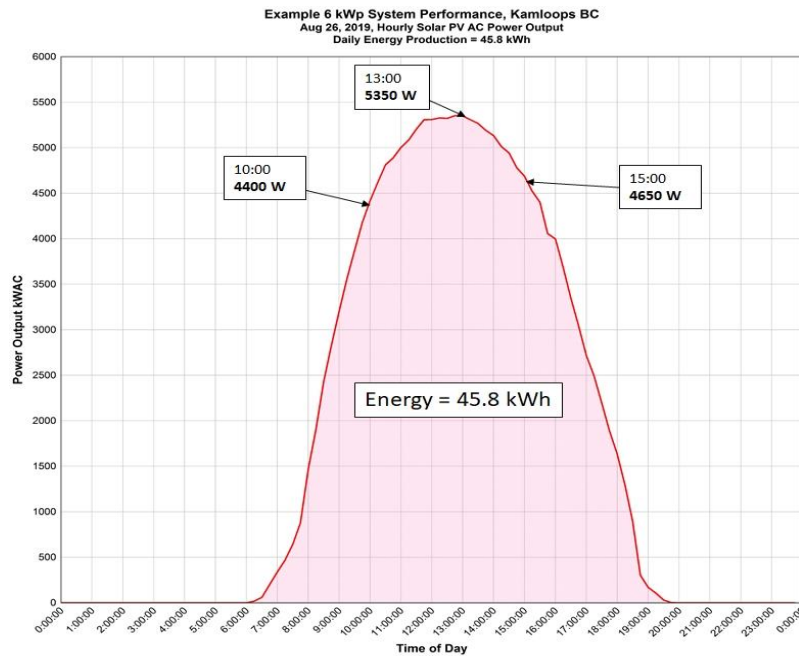

Figure 38: 6 kWp PV System AC Output Power, Aug 26, 2019 - courtesy Riverside Energy Systems

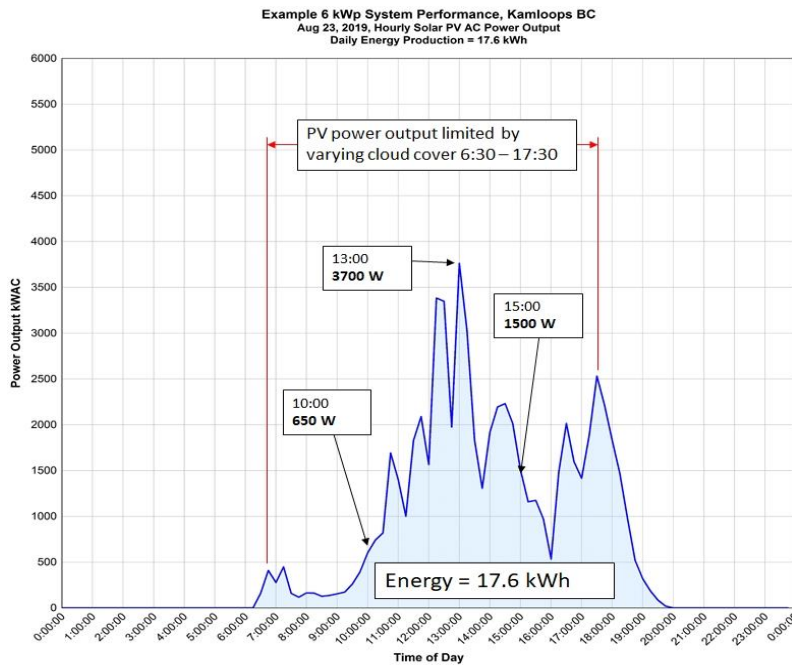

Figure 39: 6 kWp PV System Output Power, Aug 23, 2019 - courtesy Riverside Energy Systems

**3. How can I be confident site solar access quality and shading constraints have been properly accounted for in my project?**

Predicting solar PV system performance with confidence requires site solar access quality and shading constraints to be accounted for using recognized site assessment methods and equipment. Reputable PV consultants will routinely perform site specific solar access and shading measurements in the regular course of assessing sites and designing solar PV systems. To verify site suitability, formal solar access and shading measurements reporting are commonly mandatory in jurisdictions offering solar PV incentives. Builders and homeowners are advised to require comparable due diligence of their solar PV consultant during the integrated design stage of their project.

Purpose specific solar photographic equipment and software are commonly used to measure solar access scores and shading constraints. Figure 40 shows analysis results using an industry standard solar photographic tool for two prospective solar PV sites (A and B) on the same property.

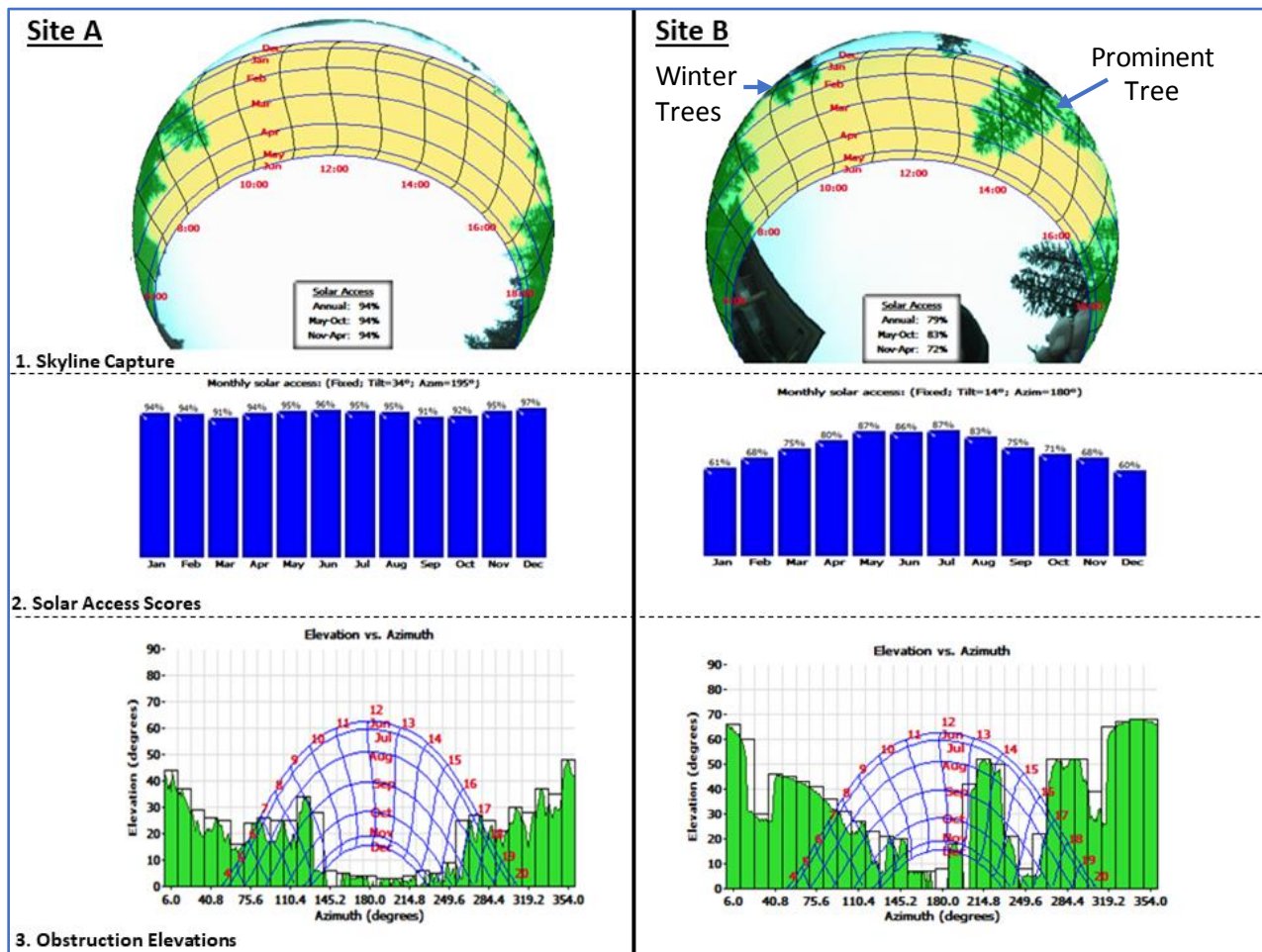

Figure 40: Solar Access and Shading Analysis - Contrasting Two Sites - courtesy of Riverside Energy Systems



Within the figure, successive rows show comparative Skyline Capture, Solar Access Scores, and Obstruction Elevation plots for each site as described below.

- **Skyline Capture** – 360-degree horizon fish-eye capture with latitude based annual sun-paths superimposed to highlight solar access constraints and shading obstacles. Calculated annual and seasonal solar access score summaries are also shown.
- **Solar Access Scores** – Calculated monthly percentage available sun hours that will not be compromised by shading obstructions.
- **Obstruction Elevations** – Obstruction elevations show the azimuth and elevation angles at which shading obstructions can be expected to compromise solar access for each month of the year.

Comparing Skyline Captures, site A can be seen to have significantly fewer shading obstacles blocking sun paths. In particular, site B is more shade compromised by trees and a neighboring building to the East. This is confirmed by site A monthly Solar Access Scores being consistently above 90% in contrast to site B as low as 60% (Dec) and no higher than 87% (May and Aug). The Obstruction Elevation plots clearly show three-season afternoon and winter morning solar obstructions at site B in contrast to the considerably less unobstructed sun paths of site A year-round.

Solar photographic measurements confirm numerically the expected solar PV array effectiveness of a site, and assist in comparing array placement options. Solar photographic software tools can be used to predict the benefits of strategies such as tree topping to improve solar access. Solar access scores and obstruction elevation data measured with site solar photography are used by solar PV consultants to refine solar PV performance models, more confidently predict site specific solar PV performance, refine system designs, and advise integrated design team decisions.

#### 4. How significantly will array orientation affect solar PV energy production for my project?

Roof mounted solar PV performance is influenced by roof orientation (azimuth and pitch), site latitude, and annual climate patterns. Important questions often arise about how significantly off-south roof orientations or differing roof pitches will impact the energy production of solar PV arrays. A solar PV consultant can carefully account for these when projecting solar energy harvests and providing design guidance. It is valuable for builders to have a practical sense of these effects early in the integrated design process before roof designs are finalized.

Solar PV array orientations are described using compass direction (azimuth angle relative to true North) and pitch (horizontal tilt angle) as shown in Figure 41. The example solar module is oriented at 240° azimuth and 45° tilt.

Generally, Canadian rooftop solar PV energy production is maximized with azimuth as close to true South as possible and roof pitch angle somewhere between latitude and latitude-15°. Builders and architects often wonder whether changes to roof orientation and/or pitch to maximize solar

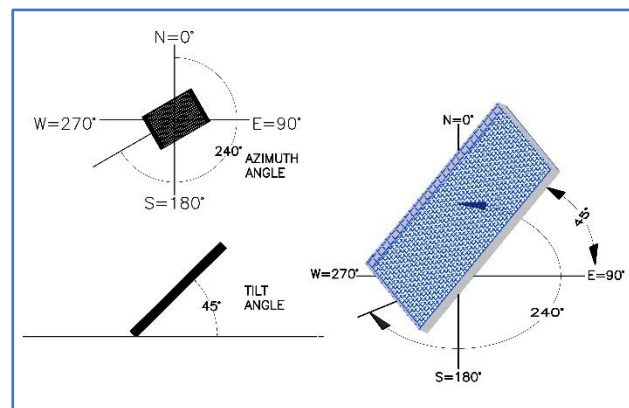

Figure 41: Solar PV Array Orientations - Azimuth and Tilt Angle  
- courtesy of Riverside Energy Systems

PV energy production are justified. Provided roof azimuth is within 30° of true South, it is usually more practical to increase solar array capacity than to modify building design to compensate for non-ideal roof orientations; provided roof space permits.

Figure 42 shows predicted solar PV production % versus azimuth and tilt for Red Deer AB, (latitude 52.3° N). Production of 100% represents outcomes for ideal orientation at true South azimuth and about 45° tilt (12:12 pitch) at this latitude. At 12:12 pitch, azimuth up to 45° off of true South reduces annual energy production by only 9% versus direct south orientation. At shallower roof pitches 6:12 (25°) and 3:12 (15°), up to 45° off-south azimuth reduces annual energy production even less; 6% and 4% respectively. Pitch changes impact annual energy production somewhat more significantly the closer roof azimuth is to directly true South.

A solar PV consultant will analyze array orientation impacts using project specific solar modelling to provide integrated design team guidance around roof orientation concerns.

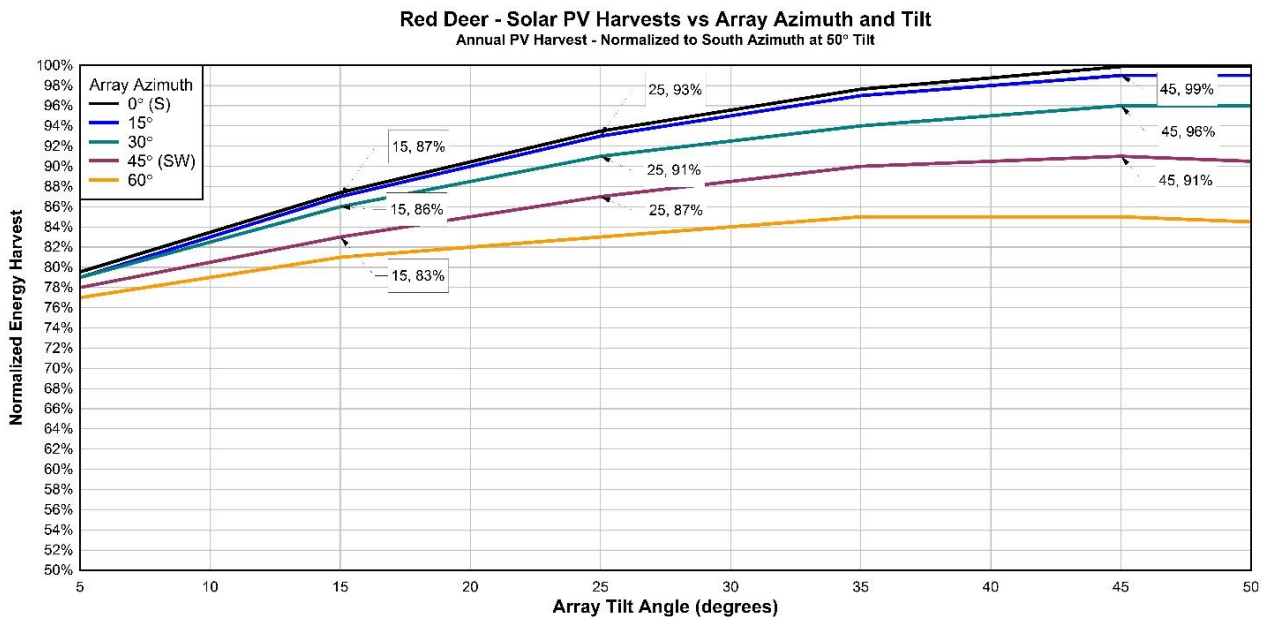

Figure 42: Red Deer AB, Effects of Azimuth and Tilt on Annual Solar PV Energy Production - courtesy Riverside Energy Systems

**5. Can you explain the difference between “Net-Zero-Energy” and “Net-Zero-Electricity”?**

Differing understandings of the term “Net-Zero” commonly exist amongst residential builders, writers of Building Code, and electrical utilities. It is valuable to be aware that when discussing “Net-Zero Homes” or “Net-Zero Ready Homes”, that your interpretation of the terms may be different that the people you are engaging with.

Residential builders and writers of Building Code typically intend “Net-Zero” to mean that over the course of a 365-day-cycle, consumption of all forms of energy (electricity, natural gas, propane, etc.) will be totally offset by on site solar PV generation; more clearly described as “Net-Zero Energy”. Some electric utilities do not allow solar PV energy production in excess of the home’s annual electrical energy need; more clearly described as “Net-Zero Electricity”. In jurisdictions where utilities cap solar PV system designs at “Net-Zero Electricity” energy production, “Net-Zero Energy” and Net-Zero home certification can only be achieved using all electric mechanical systems.

The integrated design team should carefully consider how electrical utility constraints may impact mechanical systems fuel choices and the desired energy performance outcomes for the project.

**6. What are the additional concerns when building an entire solar PV grid connected community?**

Residential developments with a proposed high concentration of solar PV equipped homes, or shared community owned solar PV resources typically require careful electrical utility review. Projects of this nature are more likely to raise electrical utility concerns over infrastructure capacity limits, distribution circuit control and protection reliability, revenue metering standards, electrical billing practices, etc. and to require unique electrical design features within the community.

Early consultations and review by the electrical utility and PV consultant are highly advised to identify technical challenges, confirm feasibility, and secure advanced approval for proposed community solar PV strategies in advance of detailed planning and design.

# APPENDIX B: Solar PV System Integration Worksheet

## PART I: Pre-Design Considerations

### Integrated Design Team:

Builder: \_\_\_\_\_

Energy Advisor: \_\_\_\_\_

PV Designer: \_\_\_\_\_

Other trades: \_\_\_\_\_

### STEP 1: Builder's Preferred Goal for Solar PV *(circle one)*

- Option 1A: PV Ready Home
- Option 1B: PV Equipped Home
- Option 1C: Net-Zero Ready (NZr) Home
- Option 1D: Net Zero (NZ) Energy Home

### STEP 2: Utility Connection Options and Constraints at the Build Site *(circle one and provide details)*

- Option 2A: Feed-in-Tariff (FIT)
- Option 2B: Net-Metering / Net Billing
- Option 2C: Net-Zero Electric
- Option 2D: Self-Use Only
- Option 2E: No Grid Connection Available

Maximum PV Array capacity allowed for grid connection: \_\_\_\_\_ kW<sub>peak</sub>

Maximum PV Energy Production allowed for grid connection: \_\_\_\_\_ kWh/y

### STEP 3: Confirm Solar PV Integration Design Requirements

Confirm general design requirements with Integrated Design Team using the STEP 1 & 2 decisions together with the provided "Planning Matrix" to secure Builder approval to proceed with the detailed design.

- A. **Building Envelope:** Normal build / envelope upgrades *(circle one)*
- B. **HVAC mechanicals:** Standard equipment / enhanced efficiency / all-electric *(circle all that apply)*
- C. **PV Integration:** PV-Ready installation / Full PV Installation *(circle one)*
- D. **Battery Integration:** Battery not required / Battery-Ready / Full battery installation *(circle one)*
- E. **PV Inverter Type:** Inverter not required / Grid-tied inverter / Bi-modal inverter *(circle one)*

## PART II: Solar PV Integration Design Requirements

### STEP 4: Define Annual PV Energy Production Target *(circle one option and provide details)*

- Option 4A: No Specified Energy Target (Max. solar array area available: \_\_\_\_\_ ft<sup>2</sup> or m<sup>2</sup>)
- Option 4B: Partial energy offset Target (Nominal PV energy target: \_\_\_\_\_ kWh/y)
- Option 4C: Net-Zero Energy Usage (Nominal PV target: \_\_\_\_\_ kWh/y)

Solar photography completed to measure solar access scores and shading constraints at site: Yes / No

Measured annual solar access score: \_\_\_\_\_%. Summer: \_\_\_\_\_%. Winter: \_\_\_\_\_%.

### STEP 5: Define PV Array Location(s) and Size(s) *(circle all options that apply and provide details)*

- Option 5A: House-roof mounted (array area available: \_\_\_\_\_ ft<sup>2</sup> or m<sup>2</sup>)
- Option 5B: Adjacent-structure, specify: \_\_\_\_\_ (array area available: \_\_\_\_\_ ft<sup>2</sup> or m<sup>2</sup>)
- Option 5C: Ground-mounted (array area available: \_\_\_\_\_ ft<sup>2</sup> or m<sup>2</sup>)
- Solar Access and Shading Assessment for the preferred array location(s):
  - Estimated PV Energy Production: \_\_\_\_\_ kWh/y
  - Shading *(circle all that apply)*: External-shading: Yes / No ; Self-shading: Yes / No

**STEP 6: Define Electrical Requirements for Solar PV** (circle one option and provide details)

- Option 6A: Feed-in-Tariff (FIT) circuit breaker (C/B rating: \_\_\_\_\_ A)
- Option 6B: Main-panel circuit breaker (C/B rating: \_\_\_\_\_ A);  
specify main panel bus-bar rating: \_\_\_\_\_ A
- Option 6C: Service Splitter with solar disconnect (solar C/B rating: \_\_\_\_\_ A)

Other components: (circle all that apply)

- Battery Storage Required: yes / no
- Self-Use Controller Required: yes / no
- Bi-modal Inverter/Charger required: yes / no

**STEP 7: Structural Impacts and preferred PV Attachment Method**

Structural impacts assessed and recommended attachment method defined: No / Yes (circle one)

If No, arrange for structural review with input from the PV consultant.

If Yes, indicate type of assessment: Professional structural assurances provided: Yes / No (circle one)

Truss manufacturer assurances provided: Yes / No (circle one)

**and, select the preferred attachment method:** (circle one option or sub-option)

- Option 7A: Flashed anchors secured into roof sub-structure: (select one sub-option)  
(i) J or U-bolts; (ii) Lag-bolts into blocking; (iii) Lag-bolts into scabs; (iv) Lag bolts into top-chords\*
- Option 7B: Flashed anchors secured into roof decking
- Option 7C: Standing seam metal roof clamps
- Option 7D: Ballasted systems (only suitable on roofs with less than 7-degrees of slope)
- Other method \_\_\_\_\_ (specify)

**\* WARNING: DIRECT LAGGING INTO ROOF-TRUSS TOP CHORDS IS NOT RECOMMENDED BY TPIC**

## PART III: Preferred Solar Components & Monitoring

**STEP 8: Preferred Solar Module Technology** (select one)

- Option 8A: Polycrystalline-Cell Modules
- Option 8B: Monocrystalline-Cell Modules (basic)
- Option 8C: Monocrystalline-Cell, All black Modules
- Option 8D: Monocrystalline-Cell, Bi-facial Modules
- Other requirements \_\_\_\_\_ (specify)

**STEP 9: Preferred Inverter Technology** (select one)

- Option 9A: String Inverter
- Option 9B: Optimized-String Inverter
- Option 9C: Micro-Inverter
- Option 9D: Bi-Modal Inverter
- Other requirements \_\_\_\_\_ (specify)

**STEP 10: Preferred Energy Monitoring Approach** (Required for NZ homes; optional for others)

- Option 10A: Monitoring not installed
- Option 10B: Basic Net-Zero Home monitoring
- Option 10C: Advanced energy monitoring of the home
- Other requirements \_\_\_\_\_ (specify)